

# Operating instructions Analytical balance

## KERN ABS-N\_ABJ-NM

Version 1.2  
03/2013  
GB





# KERN ABS-N\_ABJ-NM

Version 1.2 03/2013

## Operating instructions

### Analytical balance

#### Table of Contents

<b>1</b>	<b>Technical Specifications .....</b>	<b>4</b>
<b>2</b>	<b>Declaration of conformity .....</b>	<b>7</b>
<b>3</b>	<b>Appliance overview .....</b>	<b>8</b>
<b>3.1</b>	<b>Keyboard overview.....</b>	<b>9</b>
3.1.1	Numeric entry .....	10
<b>3.2</b>	<b>Overview of displays.....</b>	<b>11</b>
<b>4</b>	<b>Basic Information (General).....</b>	<b>12</b>
4.1	Proper use .....	12
4.2	Improper Use.....	12
4.3	Warranty .....	12
4.4	Monitoring of Test Resources.....	13
<b>5</b>	<b>Basic Safety Precautions .....</b>	<b>13</b>
5.1	Pay attention to the instructions in the Operation Manual .....	13
5.2	Personnel training .....	13
<b>6</b>	<b>Transportation &amp; Storage.....</b>	<b>13</b>
6.1	Testing upon acceptance .....	13
6.2	Packaging / return transport .....	14
<b>7</b>	<b>Unpacking, Setup and Commissioning .....</b>	<b>16</b>
7.1	Installation Site, Location of Use .....	16
7.2	Unpacking and checking .....	16
7.2.1	Scope of delivery / serial accessories.....	17
7.2.2	Placing .....	18
7.3	Mains connection .....	19
7.3.1	Turning On the Power.....	19
7.4	Initial Commissioning .....	19
7.5	Connection of peripheral devices.....	19
<b>8</b>	<b>Adjustment .....</b>	<b>20</b>
8.1	Automatic adjustment by PSC (Perfect Self Calibration), only models ABJ .....	20
8.2	Menu settings „I.CAL“ / „E.CAL“ .....	23
8.2.1	Adjustment with internal weight (KERN ABJ) .....	24
8.2.2	Adjustment with external weight (KERN ABS).....	25
8.3	Adjustment log.....	26
8.4	Balance identification no. ....	27
<b>9</b>	<b>Verification .....</b>	<b>28</b>
<b>10</b>	<b>Weighing.....</b>	<b>30</b>
10.1	Switch-on balance / call-up weighing mode .....	30
10.2	Switch off the balance.....	30
10.3	Set the start display.....	31
10.4	Auto Power-Off function (automatic switch-off function) .....	33
10.5	Simple weighing .....	34
10.6	Taring.....	35
10.7	Switch-over weighing unit.....	36

10.7.1	Freely programmable weighing unit .....	37
10.7.2	Change position of decimal dot for freely programmable weighing unit.....	38
10.7.3	Input minimum weight for freely programmable weighing unit .....	38
<b>10.8</b>	<b>Change readability (1D/10D).....</b>	<b>39</b>
<b>10.9</b>	<b>Display decimal dot as point or comma.....</b>	<b>40</b>
<b>11</b>	<b>Menu .....</b>	<b>41</b>
11.1	Menu symbol.....	41
11.2	Navigation in the menu .....	42
11.3	Menu overview.....	43
11.4	Resetting the menu .....	44
11.5	Menu Lock.....	45
11.5.1	Change password .....	46
11.6	Log menu settings.....	47
<b>12</b>	<b>Zero / tare menu (zeroing and taring functions) .....</b>	<b>48</b>
12.1	Zero tracking function.....	49
12.2	Auto zero function .....	50
12.3	Auto Tare function.....	51
12.4	Zero / tare timing change function.....	52
<b>13</b>	<b>Settings for Stability and Response.....</b>	<b>53</b>
13.1	Stability and reaction settings via „Easy Setting display“ (without invoking menu).....	53
13.2	Selection weighing / dosing mode .....	54
13.3	Standstill width .....	55
<b>14</b>	<b>Application Functions .....</b>	<b>57</b>
14.1	Parts counting .....	57
14.2	Percent determination.....	60
14.2.1	Reference weight = 100 % .....	61
14.2.2	User-defined reference .....	62
14.2.3	Percent determination .....	63
14.3	Formula mode.....	64
14.3.1	Enable edition „component no.“ .....	66
14.3.2	Enable issue „TOTAL“ .....	67
<b>15</b>	<b>Check weighing and target mode (check and target weighing) .....</b>	<b>68</b>
15.1	Check weighing .....	68
15.2	Target mode .....	72
<b>16</b>	<b>Data output.....</b>	<b>75</b>
16.1	Pin connection.....	75
16.2	Issue functions .....	76
16.2.1	Automatic data output / Auto Print function .....	76
16.2.2	Continuous Output function.....	78
16.2.3	Output Timing Change function .....	80
16.2.4	GLP Output function / balance identification number .....	81
16.3	Communication parameters .....	82
16.3.1	Selection of a standard setting „MODE 1 - MODE 5“.....	83
16.3.2	User-defined settings „MODE U“ / setting for KERN –YKB-01N.....	84
16.4	Data Formats.....	88
16.5	Remote control instructions.....	92
<b>17</b>	<b>Service, maintenance, disposal.....</b>	<b>93</b>
17.1	Cleaning.....	93
17.2	Service, maintenance .....	95
17.3	Disposal.....	95
<b>18</b>	<b>Instant help.....</b>	<b>95</b>
18.1	Error messages.....	96

# 1 Technical Specifications

KERN	ABJ 80-4NM	ABJ 120-4NM	ABJ 220-4NM	ABJ 320-4NM
Readability (d)	0.1 mg	0.1 mg	0.1 mg	0.1 mg
Weighing range (max)	80 g	120 g	220 g	320 g
Minimum load (Min)	10 mg	10 mg	10 mg	10 mg
Verification value (e)	1 mg	1 mg	1 mg	1 mg
Verification class	I	I	I	I
Reproducibility	0.2 mg	0.2 mg	0.2 mg	0.2 mg
Linearity	± 0.3 mg	± 0.3 mg	± 0.3 mg	± 0.3 mg
Stabilization time	3 sec.			
Adjustment weight	internal			
Warm-up time	4 h	8 h	8 h	8 h
Weighing Units	mg, g	mg, g, ct		
Smallest part weight for piece counting	1 mg			
Reference quantities at piece counting	5, 10, 20, 50,100			
Weighing plate, stainless steel	ø 91mm			
Dimensions of the housing (B x D x H) [mm]	210 x 340 x 325			
Dimensions Glass wind screen [mm]	174 x 162 x 227 (weighing space)			
Net weight (kg)	6			
Permissible ambient condition	+10° C bis +30° C			
Humidity of air	20 ~ 85 % relative (not condensing)			
AC adapter (Primary)	AC 100 -240 V, 400 mA 50/60Hz			
Rated electric power supply	DC 12 V, 1.25 A			
Pollution Degree	2			
Overvoltage Category	Category II			
Altitude	Up to 2000 m			
Installation Site	device may only be used indoors			

<b>KERN</b>	<b>ABS 80-4N</b>	<b>ABS 120-4N</b>
Readability (d)	0.1 mg	0.1 mg
Weighing range (max)	80 g	120 g
Reproducibility	0.2 mg	0.2 mg
Linearity	± 0.3 mg	± 0.3 mg
Recommended adjusting weight not supplied (class)	80 g (E2)	100 g (E2)
Warm-up time	4 h	8 h
Stabilization time	3 sec.	
Weighing Units	mg, g	mg, g, ct
Smallest part weight for piece counting	1 mg	
Reference quantities at piece counting	5, 10, 20, 50, 100	
Weighing plate, stainless steel	ø 91mm	
Dimensions of the housing (B x D x H) [mm]	210 x 340 x 325	
Dimensions Glass wind screen [mm]	174 x 162 x 227 (weighing space)	
Net weight (kg)	6	
Permissible ambient condition	+5° C to +40° C	
Humidity of air	20 ~ 85 % relative (not condensing)	
AC adapter (Primary)	AC 100 -240 V, 400 mA 50/60Hz	
Rated electric power supply	DC 12 V, 1.25 A	
Pollution Degree	2	
Overvoltage Category	Category II	
Altitude	Up to 2000 m	
Installation Site	device may only be used indoors	

<b>KERN</b>	<b>ABS 220-4N</b>	<b>ABS 320-4N</b>
Readability (d)	0.1 mg	0.1 mg
Weighing range (max)	220 g	320 g
Reproducibility	0.2 mg	0.2 mg
Linearity	± 0.3 mg	± 0.3 mg
Recommended adjusting weight not supplied (class)	200 g (E2)	300 g (E2)
Stabilization time	3 sec.	
Warm-up time	8 h	
Weighing Units	mg, g, ct	
Smallest part weight for piece counting	1 mg	
Reference quantities at piece counting	5, 10, 20, 50,100	
Weighing plate, stainless steel	ø 91mm	
Dimensions of the housing (B x D x H) [mm]	210 x 340 x 325	
Dimensions Glass wind screen [mm]	174 x 162 x 227 (weighing space)	
Net weight (kg)	6	
Permissible ambient condition	+5° C to +40° C	
Humidity of air	20 ~ 85 % relative (not condensing)	
AC adapter (Primary)	AC 100 -240 V, 400 mA 50/60Hz	
Rated electric power supply	DC 12 V, 1.25 A	
Pollution Degree	2	
Overvoltage Category	Category II	
Altitude	Up to 2000 m	
Installation Site	device may only be used indoors	

## 2 Declaration of conformity



**KERN & Sohn GmbH**  
D-72322 Balingen-Frommern  
Postbox 4052  
email: [info@kern-sohn.de](mailto:info@kern-sohn.de)

Phone: 0049-[0]7433-9933-0  
Fax: 0049-[0]7433-9933-149  
Internet: [www.kern-sohn.de](http://www.kern-sohn.de)

### Declaration of conformity

EC-Konformitätserklärung  
EC- Déclaration de conformité  
EC-Dichiarazione di conformità  
EC- Declaração de conformidade  
EC-Deklaracja zgodności

EC-Declaration of -Conformity  
EC-Declaración de Conformidad  
EC-Conformiteitverklaring  
EC- Prohlášení o shode  
ЕС-Заявление о соответствии

<b>EN</b>	Konformitäts- erklärung	Wir erklären hiermit, dass das Produkt, auf das sich diese Erklärung bezieht, mit den nachstehenden Normen übereinstimmt.
<b>GB</b>	Declaration of conformity	We hereby declare that the product to which this declaration refers conforms to the following standards.
<b>CZ</b>	Prohlášení o shode	Tímto prohlašujeme, že výrobek, kterého se toto prohlášení týká, je v souladu s níže uvedenými normami.
<b>E</b>	Declaración de conformidad	Manifestamos en la presente que el producto al que se refiere esta declaración está de acuerdo con las normas siguientes
<b>F</b>	Déclaration de conformité	Nous déclarons avec cela responsabilité que le produit, auquel se rapporte la présente déclaration, est conforme aux normes citées ci-après.
<b>I</b>	Dichiarazione di conformità	Dichiariamo con ciò che il prodotto al quale la presente dichiarazione si riferisce è conforme alle norme di seguito citate.
<b>NL</b>	Conformiteit- verklaring	Wij verklaren hiermede dat het product, waarop deze verklaring betrekking heeft, met de hierna vermelde normen overeenstemt.
<b>P</b>	Declaração de conformidade	Declaramos por meio da presente que o produto no qual se refere esta declaração, corresponde às normas seguintes.
<b>PL</b>	Deklaracja zgodności	Niniejszym oświadczamy, że produkt, którego niniejsze oświadczenie dotyczy, jest zgodny z poniższymi normami.
<b>RUS</b>	Заявление о соответствии	Мы заявляем, что продукт, к которому относится данная декларация, соответствует перечисленным ниже нормам.

### Electronic Balance: KERN ABJ-NM, ABS-N

EU Directive	Standards
2004/108/EC	EN 61326-1:2006
2006/95/EC	EN 61010-1: 2010

**Datum** 27.03.2013  
*Date*

**Ort der Ausstellung** 72336 Balingen  
*Place of issue*

**Signatur**  
*Signature*

Albert Sauter  
KERN & Sohn GmbH  
**Geschäftsführer**  
*Managing director*

KERN & Sohn GmbH, Ziegelei 1, D-72336 Balingen, Tel. +49-[0]7433/9933-0  
Fax +49-[0]7433/9933-149, E-Mail: [info@kern-sohn.com](mailto:info@kern-sohn.com), Internet: [www.kern-sohn.com](http://www.kern-sohn.com)

### 3 Appliance overview

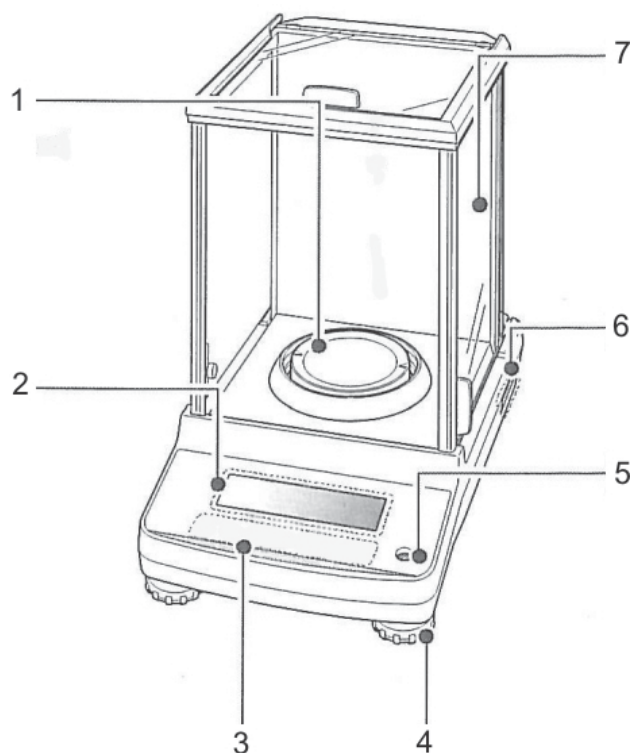

- 1. Weighing plate
- 2. Display
- 3. Keyboard
- 4. Levelling screw
- 5. Bubble level
- 6. Name plate
- 7. Wind protection
- 8. Appliance interface
- 9. Mains adapter connection

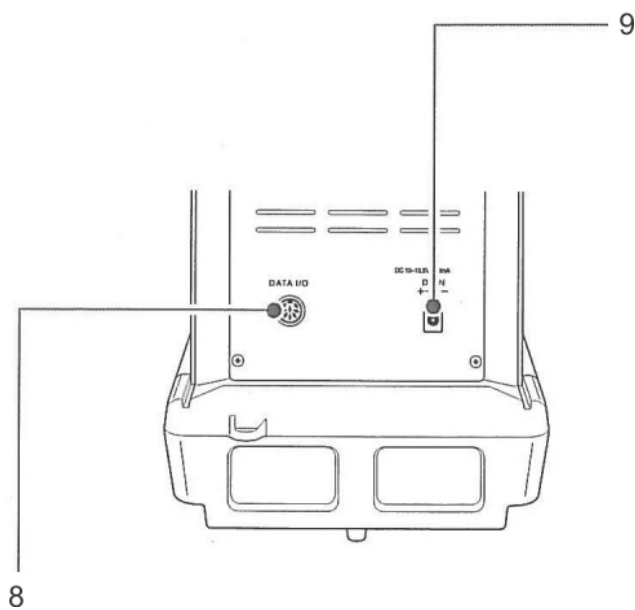





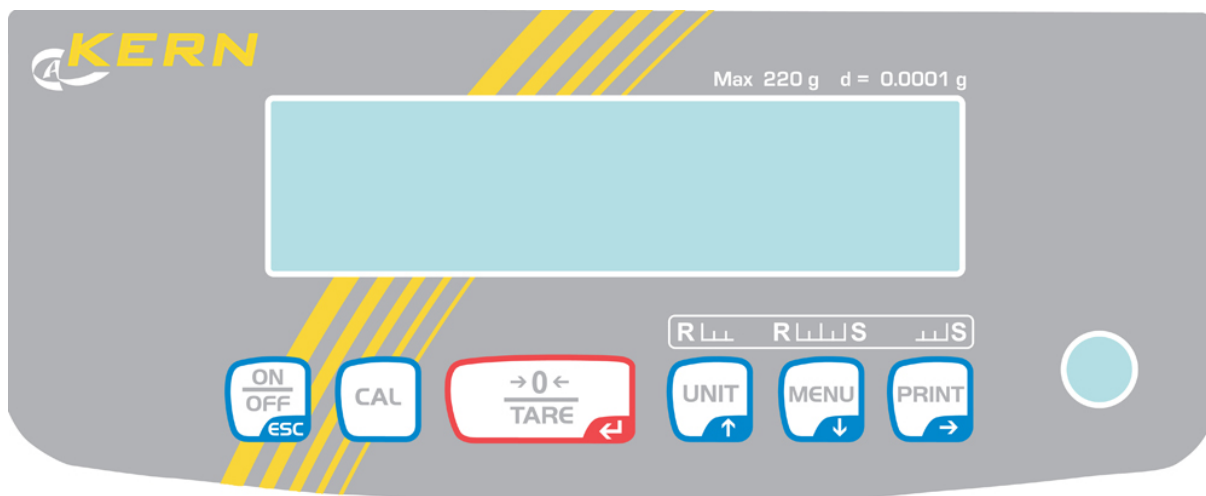

### 3.1 Keyboard overview



#### In menu:

Key	Designation:	Function		
		Pressed once and released	Keep pressed for about 3 seconds	In menu
	<b>ON/OFF</b>	Switches between the operation and standby modes.	-	Menu item back. Return to weighing mode: Press <b>ON/OFF</b> repeatedly or for 3 s. Cancel procedure
	<b>CAL</b>	Start adjustment	Invoke calibration menu	-
	<b>TARE</b>	Tare or set weight display to zero	Invoke zero / tare menu	Confirm entry
	<b>UNIT</b> ----- Navigation key ↑	Switch-over weighing unit. Display stored reference weight (PCS, %).	Invoke unit setting menu.	Scroll forward in menu
	<b>MENU</b> ----- Navigation key ↓		Switch over weighing mode / application mode	Invoke main menu (press twice) Scroll backwards in menu
	<b>PRINT</b> ----- Navigation key →	Calculate weighing data via interface	Invoke Data Output menu	Select next menu item.

### 3.1.1 Numeric entry

Key	Designation:	Function
	Navigation key ↑	Increase flashing digit Shift flashing decimal dot to the left
	Navigation key ↓	Decrease flashing digit Shift flashing decimal dot to the right
	Navigation key →	Digit selection to the right
	Navigation key ←	Confirm entry
	ESC	Cancel input

**i** With numerical input the indicator [#] appears.

## 3.2 Overview of displays

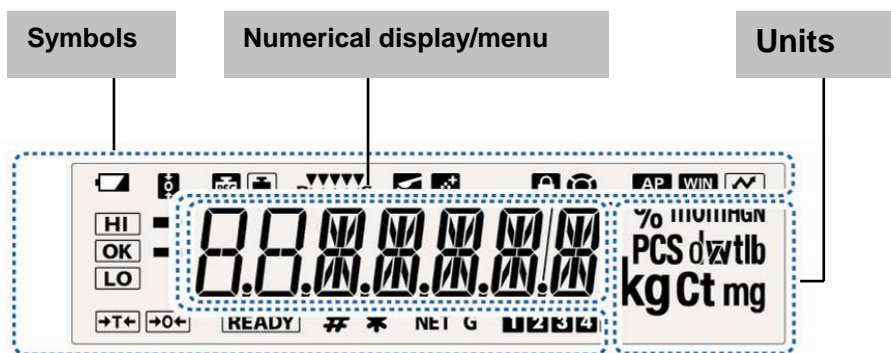

Display	Description	see chpt.
	Battery symbol	
	Zero tracking function active	➤ Chpt.12.1
	Displays adjustment	➤ Chpt. 8.2.1
	Flashes prior to start of automatic adjustment, only models ABJ	➤ Chpt. 8.1
	Stability and reaction settings via „Easy Setting display“	➤ Chpt.13.1
	Balance is in dosing mode (pouring mode)	➤ Chpt. 13.2
	Balance is in formula mode	➤ Chpt. 14.3
	Menu lock active	➤ Chpt. 11.5
	Menu symbol	➤ Chpt. 11.2
	Auto Print function active	➤ Chpt. 16.2.1
	Not documented	
	Log menu settings	
	Tolerance marks in check weighing and target mode	➤ Chpt. 15
	The stability display indicates that the weighing value is stable. Highlights current setting in the menu.	
	Negative weighed value	
	Stand-by mode Ready for start formulation Ready for start continuous data output („MANU ON“)	➤ Chpt. 10.2 ➤ Chpt. 14.3 ➤ Chpt. 16.5.2
	Indicates numeric value entry.	➤ Chpt. 3.1.1
	Shows the stored reference in piece number or percent determination mode.	➤ Chpt.14.1 ➤ Chpt.14.2.3
	Net weight in formula mode	➤ Chpt. 14.3
	Total weight (TOTAL) of all components in formula mode	➤ Chpt. 14.3
	Memory space piece weight	➤ Chpt.14.1
	Change position decimal dot for freely programmable weighing unit	➤ Chpt.10.7.2
	Balance is in piece counting mode	➤ Chpt.14.1
	Balance is in percent determination mode with user-defined reference weight	➤ Chpt.14.2.1
	Balance is in percent determination mode, reference weight =100%	➤ Chpt.14.2.2

## 4 Basic Information (General)

### 4.1 Proper use

The balance you purchased is intended to determine the weighing value of material to be weighed. It is intended to be used as a “non-automatic” balance, i.e. the material to be weighed is manually and carefully placed in the centre of the weighing plate. As soon as a stable weighing value is reached the weighing value can be read.

### 4.2 Improper Use

Do not use balance for dynamic add-on weighing procedures, if small amounts of goods to be weighed are removed or added. The “stability compensation” installed in the balance may result in displaying an incorrect measuring value! (Example: Slowly draining fluids from a container on the balance.)

Do not leave permanent load on the weighing plate. This may damage the measuring system.

Impacts and overloading exceeding the stated maximum load (max) of the balance, minus a possibly existing tare load, must be strictly avoided. Balance may be damaged by this.

Never operate balance in explosive environment. The serial version is not explosion protected.

The structure of the balance may not be modified. This may lead to incorrect weighing results, safety-related faults and destruction of the balance.

The balance may only be used according to the described conditions. Other areas of use must be released by KERN in writing.

### 4.3 Warranty

Warranty claims shall be voided in case

- Our conditions in the operation manual are ignored
- The appliance is used outside the described use
- The appliance is modified or opened
- Mechanical damage or damage by media, liquids, natural wear and tear
- The appliance is improperly set up or incorrectly electrically connected
- The measuring system is overloaded

#### **4.4 Monitoring of Test Resources**

In the framework of quality assurance the measuring-related properties of the balance and, if applicable, the testing weight, must be checked regularly. The responsible user must define a suitable interval as well as type and scope of this test. Information is available on KERN's home page ([www.kern-sohn.com](http://www.kern-sohn.com)) with regard to the monitoring of balance test substances and the test weights required for this. In KERN's accredited DKD calibration laboratory test weights and balances may be calibrated (return to the national standard) fast and at moderate cost.

### **5 Basic Safety Precautions**

#### **5.1 Pay attention to the instructions in the Operation Manual**

Carefully read this operation manual before setup and commissioning, even if you are already familiar with KERN balances.

#### **5.2 Personnel training**

The appliance may only be operated and maintained by trained personnel.

### **6 Transportation & Storage**

#### **6.1 Testing upon acceptance**

When receiving the appliance, please check packaging immediately, and the appliance itself when unpacking for possible visible damage.

## 6.2 Packaging / return transport



- ⇒ Keep all parts of the original packaging for a possibly required return.
- ⇒ Only use original packaging for returning.
- ⇒ Prior to dispatch disconnect all cables and remove loose/mobile parts.

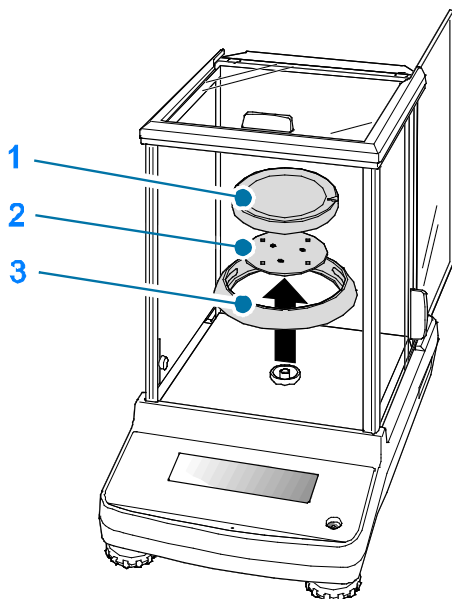

- ⇒ Reattach possibly supplied transport securing devices.
- ⇒ Secure all parts such as the glass wind screen, the weighing platform, power unit etc. against shifting and damage.

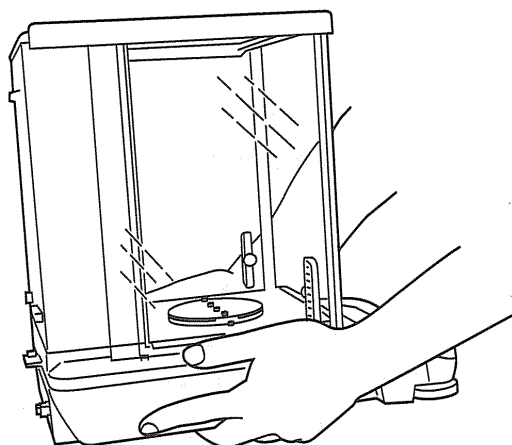

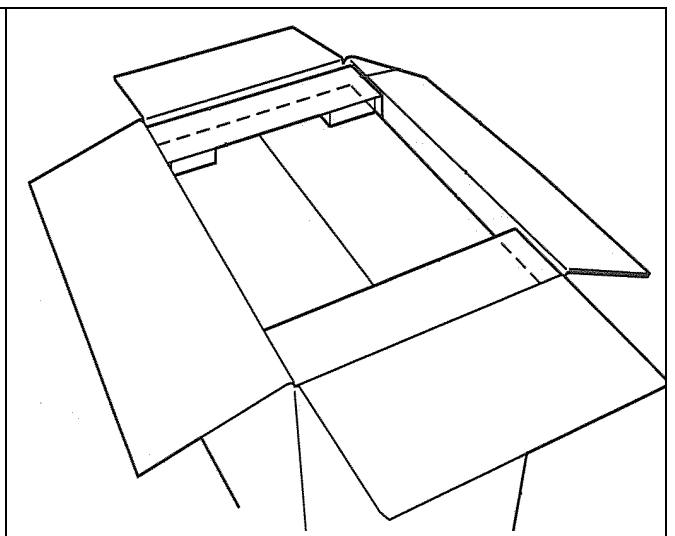
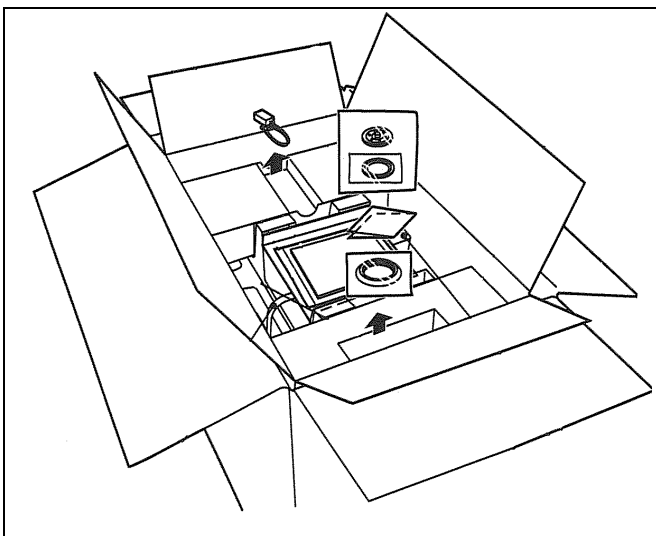
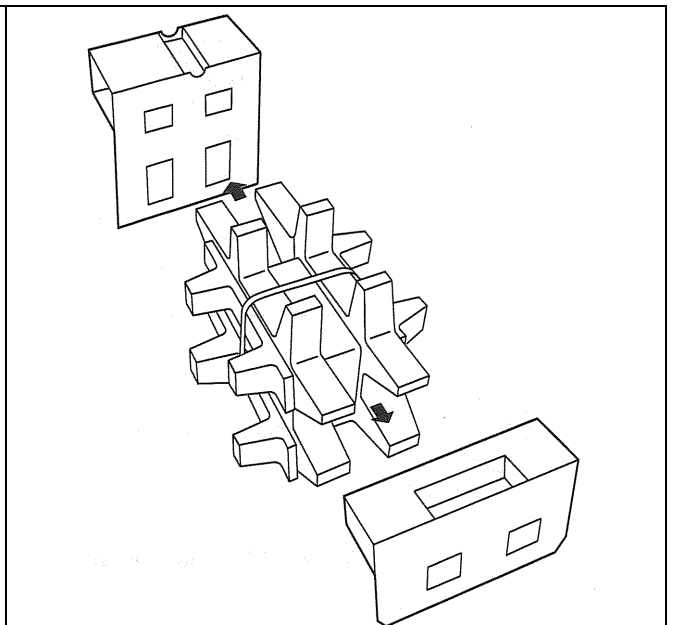
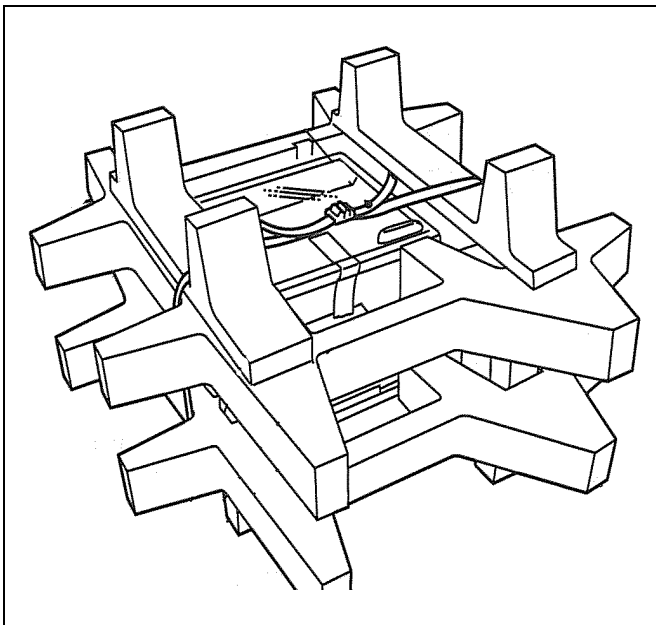
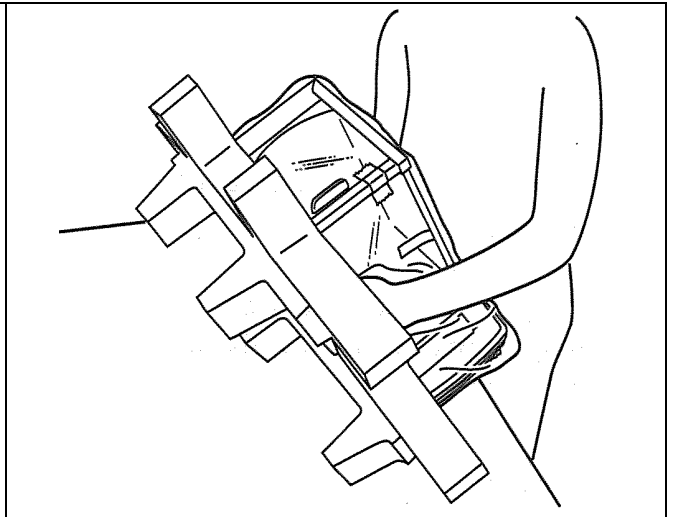
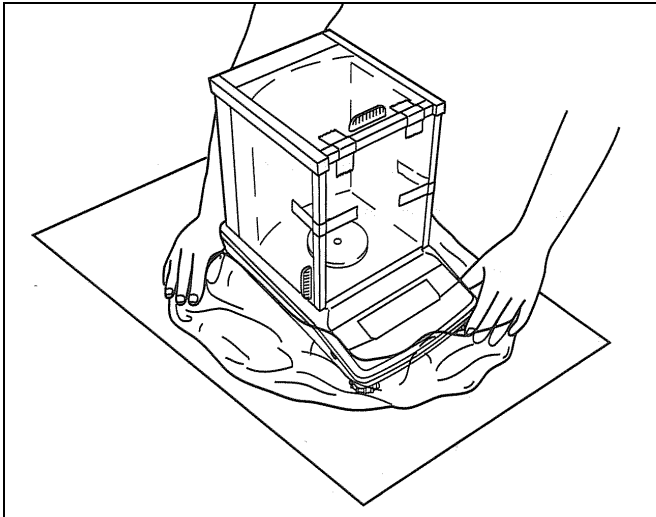

## 7 Unpacking, Setup and Commissioning

### 7.1 Installation Site, Location of Use

The balances are designed in a way that reliable weighing results are achieved in common conditions of use.

You will work accurately and fast, if you select the right location for your balance.

**Therefore, observe the following for the installation site:**

- Operate the device only indoors.
- Place the balance on a firm, level surface;
- Avoid extreme heat as well as temperature fluctuation caused by installing next to a radiator or in the direct sunlight;
- Protect the balance against direct draughts due to open windows and doors;
- Avoid jarring during weighing;
- Protect the balance against high humidity, vapours and dust;
- Do not expose the device to extreme dampness for longer periods of time. Non-permitted condensation (condensation of air humidity on the appliance) may occur if a cold appliance is taken to a considerably warmer environment. In this case, acclimatize the disconnected appliance for ca. 2 hours at room temperature.
- Avoid static charge of goods to be weighed or weighing container.

If electro-magnetic fields or static charge occur, or if the power supply is unstable major deviations on the display (incorrect weighing results) are possible. In that case, the location must be changed.

### 7.2 Unpacking and checking

Open package, take out the appliance and accessories. Verify that there has been no damage and that all packing items are present.



## 7.2.1 Scope of delivery / serial accessories

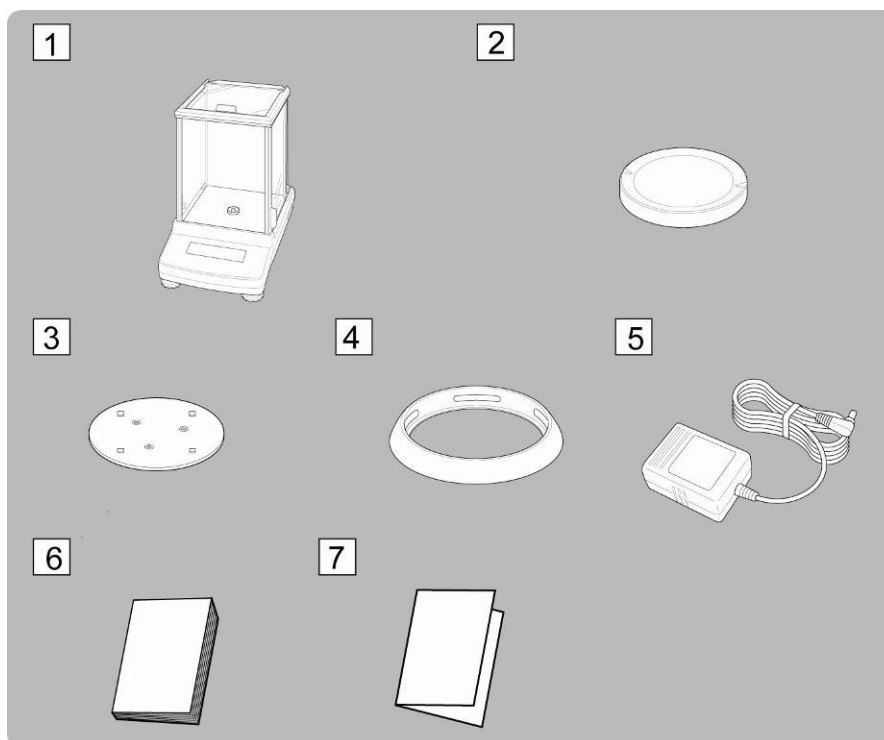

1. Balance
2. Weighing plate
3. Carrier weighing plate
4. Screening ring
5. Mains adapter
6. Operating instructions
7. Menu overview

### 7.2.2 Placing

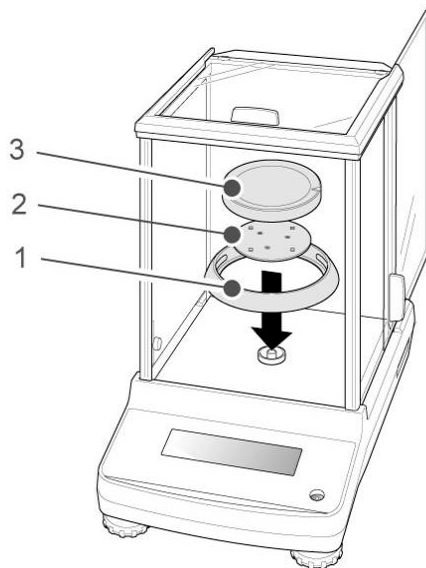

⇒ Attach circular screen, carrier of weighing plate and weighing plate in order.



⇒ Level balance with foot screws until the air bubble of the water balance is in the prescribed circle.

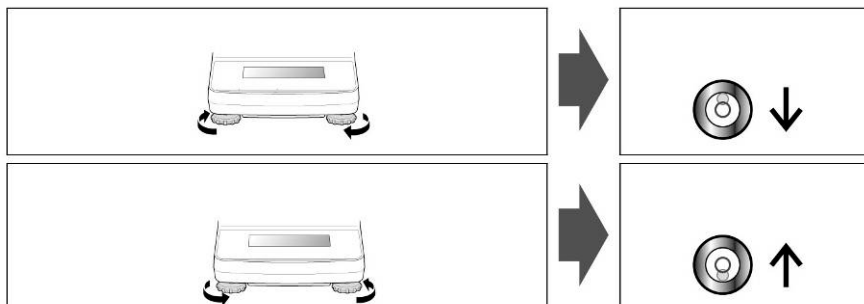
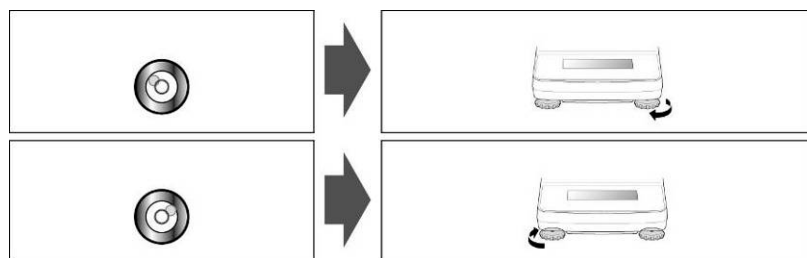

⇒ Check levelling regularly

### 7.3 Mains connection

Power is supplied via the external mains adapter. The stated voltage value must be the same as the local voltage.

Only use original KERN mains adapters. Using other makes requires consent by KERN.

#### 7.3.1 Turning On the Power

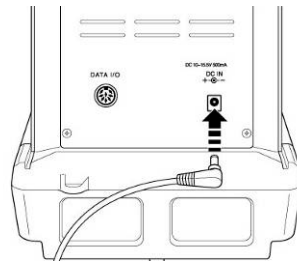

- ⇒ Supply power to balance via mains adapter. The display lights up and the balance carries out a selftest.  
In the ABJ models an automatic adjustment takes place.



- ⇒ The selftest is completed when „OFF“ appears on the display.

### 7.4 Initial Commissioning

In order to obtain exact results with the electronic balances, your balance must have reached the operating temperature (see warming up time chpt. 1). During this warming up time the balance must be connected to the power supply (mains, accumulator or battery).

The accuracy of the balance depends on the local acceleration of gravity. Strictly observe hints in chapter Adjustment.

### 7.5 Connection of peripheral devices

Before connecting or disconnecting of additional devices (printer, PC) to the data interface, always disconnect the balance from the power supply.

With your balance, only use accessories and peripheral devices by KERN, as they are ideally tuned to your balance.

## 8 Adjustment

As the acceleration value due to gravity is not the same at every location on earth, each balance must be coordinated - in compliance with the underlying physical weighing principle - to the existing acceleration due to gravity at its place of location (only if the balance has not already been adjusted to the location in the factory). This adjustment process must be carried out for the first commissioning, after each change of location as well as in case of fluctuating environment temperature. To receive accurate measuring values it is also recommended to adjust the balance periodically in weighing operation.

Observe stable environmental conditions. A warming up time (see chapter 1) is required for stabilization. Ensure that there are no objects on the weighing plate.

### 8.1 Automatic adjustment by PSC (Perfect Self Calibration), only models ABJ

The default setting for balances of the series ABJ prompts automatic adjustment via the PSC function (cannot be switched off).

The moment a change in temperature is detected this function uses the internal tare weight to carry out fully-automatic adjustment with the help of a temperature sensor. Adjustment in weighing mode is carried out automatically under the following conditions:

- (1) When there is a change in the surrounding temperature ( $\Delta t \geq 2^\circ\text{C}$ )
- (2) When about four hours has passed since the previous calibration.
- (3) When the balance is switched from standby status to weighing mode and condition (1) or (2) has been met.

If one of the above conditions was met in weighing mode, the weight symbol  flashes for about two minutes in order to notify the pending adjustment;

### Case 1: The load on the weighing plate is near zero.

The weight symbol  flashes for approx. two minutes, followed by „PSC.RUN“.

After that the internal adjustment is started automatically. In order to ensure proper PSC operation, prevent vibrations and air flow.

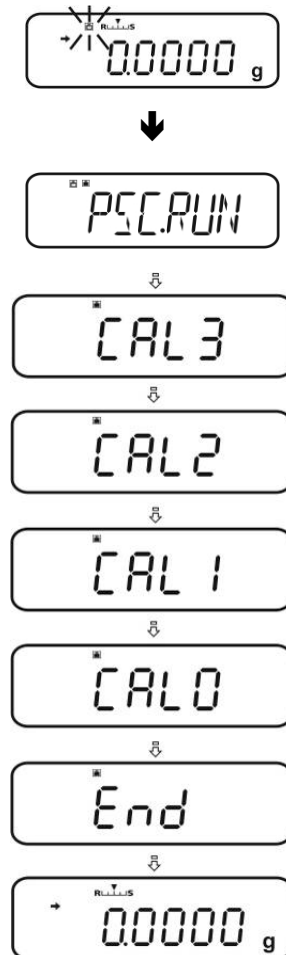

As soon as the display in grams reappears after completing adjustment via PSC, the balance returns to weighing mode.

## Case 2: Weighing plate loaded

The gram display flashes for two minutes, followed by „PLS.CAL“.

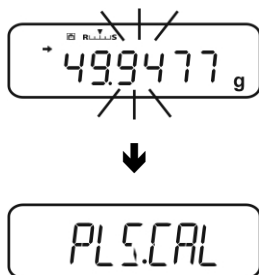

Unload weighing plate. The gram display flashes again for 2 minutes; after that the internal adjustment is started automatically. In order to ensure proper PSC operation, prevent vibrations and air flow.



As soon as the display in grams reappears after completing adjustment via PSC, the balance returns to weighing mode.



To prevent a start-up of adjustment during a measuring process, actuate the **ON/OFF** button as soon as „PLS.CAL“ is displayed. The gram display flashes again for two minutes, followed by „PLS.CAL“.

## 8.2 Menu settings „I.CAL“ / „E.CAL“

⇒ To invoke the adjustment function in weighing mode, press **CAL** for 3 sec.



⇒ Acknowledge using **PRINT**, the current setting is displayed.

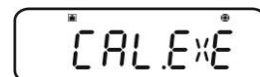

⇒ Select the desired adjustment using the navigation keys (↓ ↑)

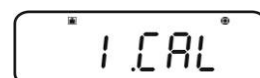

**I.CAL:** Adjustment with internal weight (see chpt. 8.1)

**E.CAL:** Adjustment with external weight (see chpt. 8.2)

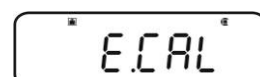

⇒ Confirm with **TARE**

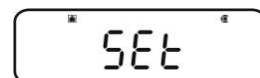

⇒ Press **ON/OFF** repeatedly or 3 sec., the balance will return into weighing mode

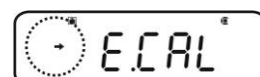

The saved adjustment (I.CAL or E.CAL) can now directly be invoked via the **CAL** button.

### 8.2.1 Adjustment with internal weight (KERN ABJ)

With the internal adjustment weight, the weighing accuracy can be checked and re-adjusted at any time.



- **Condition:** Menu setting „I.CAL“.
- When an optional printer is connected and the GLP function activated, while starting the adjustment log „WAIT“ will be displayed. After the printout the adjustment will be continued automatically.
- Adjustment may be interrupted with **ON/OFF**, „ABORT“ is displayed.

⇒ Press the **CAL**-button and adjustment will take place automatically.

The indicator  will be shown.

- ⇒ After successful adjustment the balance automatically returns to weighing mode.  
In case of an adjustment error (e.g. objects on the weighing plate) the display will show an error message, repeat adjustment.  
When an optional printer is connected and the GLP function is connected, the adjustment log will be edited, see chpt. 8.3.





## 8.2.2 Adjustment with external weight (KERN ABS)



- **Condition:** Menu setting „E.CAL“.
- The weight to be used depends on the capacity of the scale. Carry out adjustment as near as possible to the balance's maximum weight (recommended adjustment weight see chpt. 1). Weights of different nominal values or tolerance classes may be used for adjustment but are not optimal for technical measuring. The accuracy of the adjustment weight must correspond approximately to or, if possible, be better than, the readability of the balance.  
Minimum weight „Adjustment weight“:  
**ABS 80-4N / ABS 120-4N : 50 g**  
**ABS 220-4N / ABS 320-4N:100 g**  
Information about test weights you will find in the internet under:  
<http://www.kern-sohn.com>
- When an optional printer is connected and the GLP function activated, while starting the adjustment log „WAIT“ will be displayed. After the printout the adjustment process will be continued automatically.
- If during the adjustment process within 60 s no operation is carried out, „ERR C“ will be displayed. Press **ON/OFF** a restart.

⇒ In weighing mode press **CAL**. The weight value of the recommended adjustment weight (see chpt. 1) appears flashing. The indicator  will be shown.



If the value shall be changed, press **MENU**, the active digit flashes.

Carry out the desired setting using navigation buttons (see chapter 3.1.1 „Numeric input“).

⇒ With flashing adjustment weight display, place the adjustment weight carefully on the center of the weighing plate within 60 s. Close wind screen doors completely.



⇒ Wait until the zero display flashes.



⇒ Take away the adjustment weight and close the wind screen doors. After successful adjustment the balance automatically returns to weighing mode.

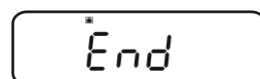

In case of an adjustment error (e.g. objects on the weighing plate) the display will show an error message, repeat adjustment.



When an optional printer is connected and the GLP function is connected, the adjustment log will be edited, see chpt. 8.3.

### 8.3 Adjustment log

This function enables automatic log issue after each adjustment. These logs may be issued by using an optional printer.

Printout example (KERN YKB-01N):

----- CAL -EXTERNAL -----	Mode of adjustment
KERN & Sohn GmbH	Company
TYPE ABJ 220-4NM	Model
SN WBIIAB000I	Serial no.
ID 1234	Balance identification no. (see chpt. 8.4)
REF 200.0000g	Used adjustment weight
BFR 200.0001g	Before adjustment
AFT 200.0000g	After adjustment
-COMPLETE	
-SIGNATURE-	prepared by
-----	



Make sure that the communication parameter of balance and printer are the same.

#### Call function

- ⇒ In weighing mode press the **CAL** key for 3 sec.
- ⇒ Use the navigation buttons (↓ ↑) to select „GLP.OUT“. The current setting is marked by the stability display (→)

With stability display (→)      Function activated

Without stability display (→)      Function disabled

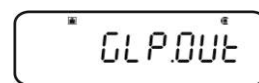
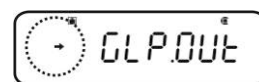
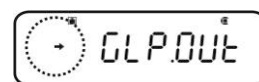
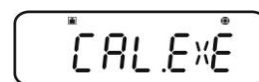

## How to change settings

⇒ Press **TARE**

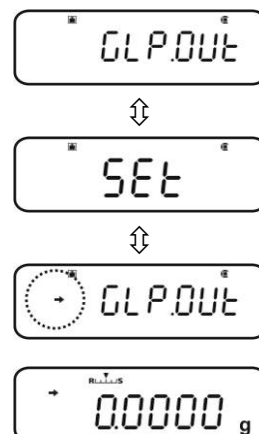

⇒ Press **ON/OFF** repeatedly or for 3 sec., the balance will return into weighing mode

## 8.4 Balance identification no.

This setting is for the balance ID number that is output along with the adjustment report.

### Call up menu

⇒ In weighing mode press the **MENU** button twice

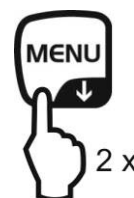

### Select menu item

⇒ Press the navigation buttons (↓ ↑) repeatedly until „**TOOLS**“ is displayed.

⇒ Confirm with **PRINT**

⇒ Press the navigation buttons (↓ ↑) repeatedly until „**SYSTEM**“ is displayed.

⇒ Confirm with **PRINT**

⇒ Press the navigation buttons (↓ ↑) repeatedly until „**BAL.ID**“ is displayed.

⇒ Press **TARE**, the currently set ID no. is displayed (factory setting 0000).

### Enter balance identification no. (max. 4 characters)

⇒ Enter the desired ID no. using navigation buttons (see chapter 3.1.1 „Numeric input“).

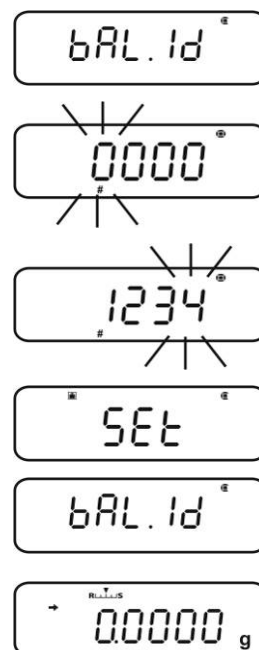

⇒ Press **ON/OFF** repeatedly or 3 sec., the balance will return into weighing mode

## 9 Verification

### General introduction:

According to EU directive 90/384/EEC or 2009/23EG balances must be officially verified if they are used as follows (legally controlled area):

- a) For commercial transactions if the price of goods is determined by weighing.
- b) For the production of medicines in pharmacies as well as for analyses in the medical and pharmaceutical laboratory.
- c) For official purposes
- d) For manufacturing final packages

In cases of doubt, please contact your local trade in standard.

### Verification notes:

An EU type approval exists for balances described in their technical data as verifiable. If a balance is used where obligation to verify exists as described above, it must be verified and re-verified at regular intervals.

Re-verification of a balance is carried out according to the respective national regulations. The validity for verification of balances in Germany is e.g. 2 years.

The legal regulation of the country where the balance is used must be observed!



### **Verification of the balance is invalid without the seal.**

The seal marks attached on verified balances point out that the balance may only be opened and serviced by trained and authorised specialist staff. If the seal mark is destroyed, verification loses its validity. Please observe all national laws and legal regulations. In Germany a re-verification will be necessary.

Position of seals

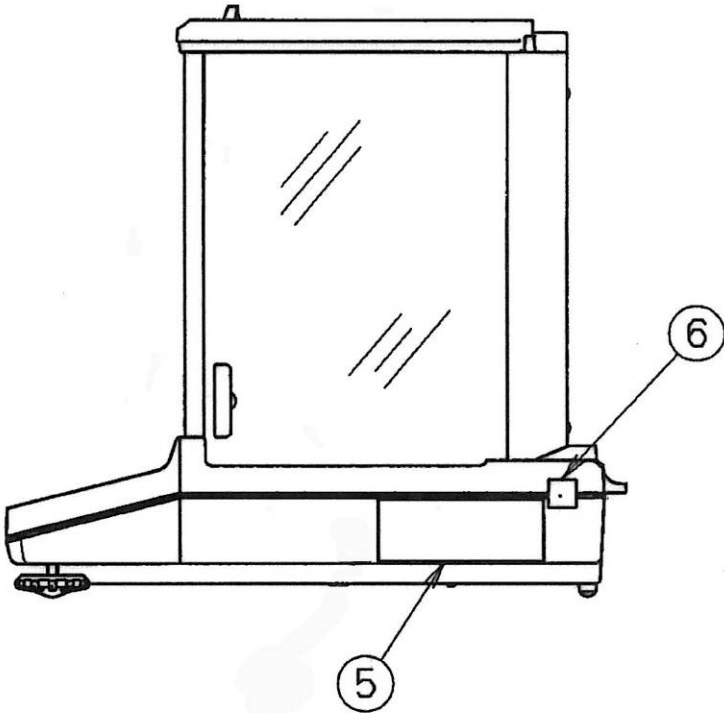
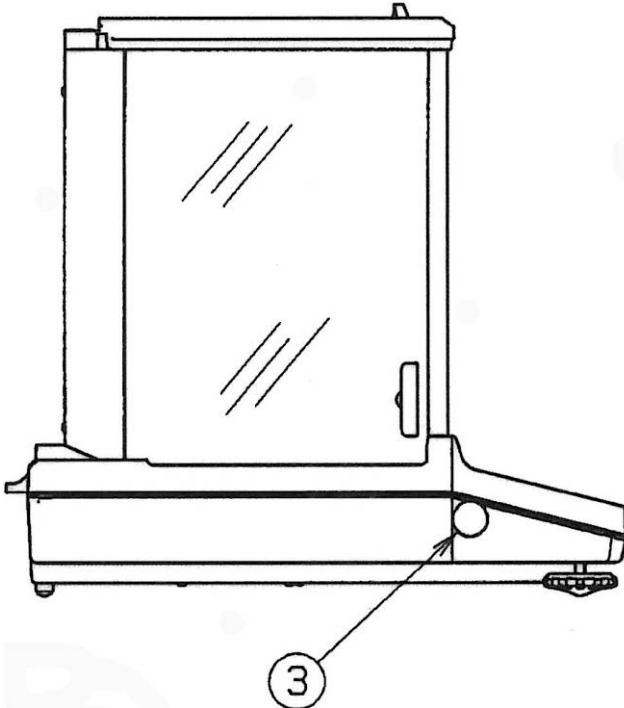

- ③ Seal
- ⑤ Data plate
- ⑥ Seal

## 10 Weighing

### 10.1 Switch-on balance / call-up weighing mode

Status balance	Call-up weighing mode
Display switched off	Press <b>ON/OFF</b> . After <i>OFF</i> display press any key
Display <i>OFF</i>	Press any key
Display <b>READY</b>	
All segments light up	
Balance is in menu	Press <b>ON/OFF</b> repeatedly or for 3 sec.
After numeric input	

### 10.2 Switch off the balance



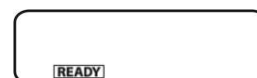



- ⇒ Press **ON/OFF**. The balance is in standby mode, that means that the balance is now in state ready-for-operation. Immediately after switching-on it is ready for operation (press any key) without warm-up time.
- ⇒ To switch-off the balance completely, separate balance from power supply.

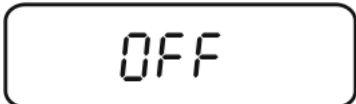

-  If **[WAIT]** or **[SET]** are displayed, do not separate the balance from power supply.

### 10.3 Set the start display

For the start display you can choose between three types.

Start display	Explanation	Menu setting
<p>1. Weighing mode</p> 	<p>After connection to the power supply the balance will start in weighing mode.</p>	
<p>2. Display OFF</p> 	<p>After connection to the power supply the balance displays OFF. After pressing a certain key the balance will carry out a segment test and start in weighing mode automatically.</p>	
<p>3. All segments</p> 	<p>After connection to the power supply the balance displays OFF. After pressing any key the balance will carry out a segment test. Only after having pressed <b>TARE</b> the weighing mode will start.</p>	

## Call up menu

- ⇒ In weighing mode press the **MENU** button twice

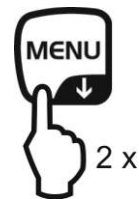

## Select menu item

- ⇒ Press the navigation buttons (↓ ↑) repeatedly until „**TOOLS**“ is displayed.
- ⇒ Confirm with **PRINT**
- ⇒ Press the navigation buttons (↓ ↑) repeatedly until „**SYSTEM**“ is displayed.
- ⇒ Confirm with **PRINT**
- ⇒ Press the navigation buttons (↓ ↑) repeatedly until „**START**“ is displayed. The current setting is marked by the stability display (→).



## Set display type

- ⇒ Acknowledge using **PRINT**, the current setting is displayed.
- ⇒ Use the navigation buttons (↓ ↑) to select the desired setting, e.g. „SEM.AUTO“.

Weighing mode



OFF display



All segments



- ⇒ Confirm with **TARE**. The current setting is marked by the stability display (→).

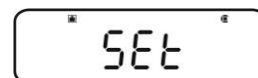

## Return to weighing mode

- ⇒ Press **ON/OFF** repeatedly or for 3 sec.





## 10.4 Auto Power-Off function (automatic switch-off function)

To save battery when function is enabled backlight of display will automatically switch off after a defined time during which there was no change of load or activity.

### 1. Call up menu

⇒ In weighing mode press the **MENU** button twice



### 2. Select function

⇒ Press the navigation buttons (↓ ↑) repeatedly until „**TOOLS**“ is displayed.

⇒ Confirm with **PRINT**

⇒ Press the navigation buttons (↓ ↑) repeatedly until „**SYSTEM**“ is displayed.

⇒ Confirm with **PRINT**

⇒ Press the navigation buttons (↓ ↑) repeatedly until „**AUTO.OFF**“ is displayed. The current setting is marked by the stability display (→).



Further steps depend on the desired setting:

Stability display (→)	Function		set/update	cancel
yes 	ON	➔	Press <b>PRINT</b> and continue with step 3.	Press <b>TARE</b> and continue with step 4.
no 	off	➔	Press <b>TARE</b> and continue with step 3.	continue with step 4.

### 3. Set time, after which the display has to switch off

⇒ Use the navigation key (↓ ↑) to enter the desired time in minutes (max. 99 min.), „Numeric input“. see chpt. 3.1.1.

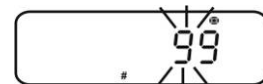

⇒ Confirm with **TARE**.

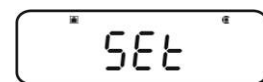

### 4. Return to weighing mode

⇒ Press **ON/OFF** repeatedly or for 3 sec.



## 10.5 Simple weighing



A warm-up time is required for stabilisation (see chpt. 1).

- ⇒ Wait for zero display, reset to zero using **TARE**.
- ⇒ Place the goods to be weighed and close the wind screen doors
- ⇒ Wait until the stability display appears [→].
- ⇒ Read weighing result.

When an optional printer is connected, the weighing value can be edited.

Print-out example with enabled GLP function (see chpt. 8.3):

----- KERN & Sohn GmbH TYPE ABJ 220-4NM SN WBIAB000I ID 1234 -----  50.0010 g  -SIGNATURE-  -----	Company Model Serial no. Balance identification no. (see chpt. 8.4)  Measuring Value prepared by
--	--

Print-out example with disabled GLP function (see chpt. 8.3):

50.0010 g	Measuring Value
-----------	-----------------

## 10.6 Taring

The dead weight of any weighing container may be tared away by pressing a button, so that the following weighings show the net weight of the goods to be weighed.

- ⇒ Put vessel of goods to be weighed on weighing plate and close the wind screen doors.
- ⇒ Wait until the stability display appears (→), then press **TARE**. The weight of the container is now internally saved.
- ⇒ Weigh the goods to be weighed and close the wind screen doors.
- ⇒ Wait until the stability display appears (→).
- ⇒ Read net weight.

### Note:



- The balance is able to only store one taring value at a time.
- When the balance is unloaded the saved taring value is displayed with negative sign.
- To delete the stored tare value, remove load from weighing pan and press **TARE**.
- The taring process can be repeated any number of times. The limit is reached when the whole weighing range is exhausted.

## 10.7 Switch-over weighing unit

By pressing the **UNIT** key, the display can be switched over to the units enabled before in the menu.

### Call up menu

⇒ In weighing mode press the **UNIT** key for 3 sec. The current setting is marked by the stability display (→).



With stability display (→)      Unit enabled

Without stability display (→)      Unit disabled

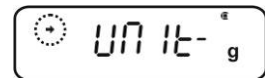
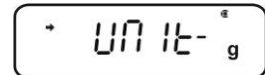

### Enable/disable units

⇒ Press **TARE**

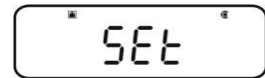

Use the navigation buttons (↓ ↑) to select more units and to enable/disable them as described before.

⇒ Press **ON/OFF** repeatedly or for 3 sec., the balance will return into weighing mode



### How to change weighing units

⇒ To return to the previously enabled weighing units go to weighing mode by **UNIT**.

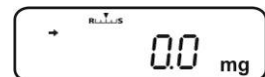

When switching-on the balance, the unit in which the balance has been switched off, will be displayed.

## 10.7.1 Freely programmable weighing unit

### Call up menu

⇒ In weighing mode press the **UNIT** key for 3 sec. Use the navigation buttons (↓ ↑) to select „UNIT.U“. The current setting is marked by the stability display (→).



With stability display (→)      Unit enabled

Without stability display (→)      Unit disabled

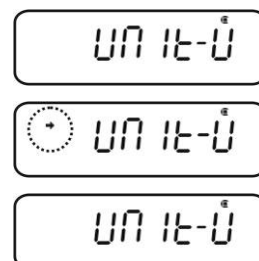

### if necessary enable units

⇒ Press **TARE**

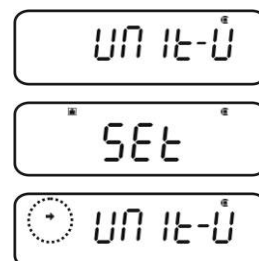

### Enter conversion factor

1. Press **TARE** and current setting will be displayed.
2. Use the navigation buttons to enter the desired conversion factor (see chapter 3.1.1 „Numeric input“).
3. Press **ON/OFF** repeatedly or for 3 sec., the balance will return into weighing mode

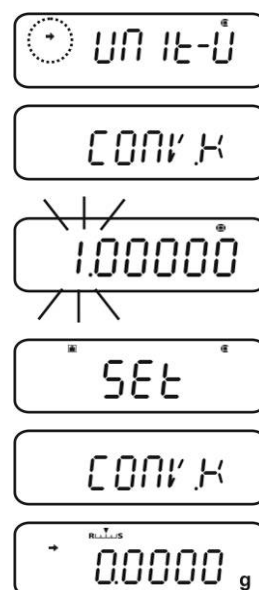

### How to change weighing units

⇒ To return to the previously enabled weighing units go to weighing mode by **UNIT**.



- With a numeric input of the conversion factor, the position of the decimal dot can be changed, see chpt. 10.7.2
- For the freely programmable weighing unit, no unit symbol will appear in the display.

### 10.7.2 Change position of decimal dot for freely programmable weighing unit

The position of the decimal dot can only be changed by a numeric input of the conversion factor (see chpt. 9.7.1, step 2).

- ⇒ When the first cipher flashes, press **PRINT** repeatedly until the decimal dot flashes.
- ⇒ Select the desired position using the navigation keys (↓ ↑). If no decimal dot shall be set, press **MENU** repeatedly until the display symbol ▼ appears.
- ⇒ Confirm with **TARE**.
- ⇒ Press **ON/OFF** repeatedly or for 3 sec., the balance will return into weighing mode

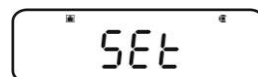

### 10.7.3 Input minimum weight for freely programmable weighing unit

#### Call up menu

- ⇒ In the menu item „**CONV.K**“ (see chpt. 9.7.1) use the navigation buttons to select (↓ ↑) „**MIN.D**“.
- ⇒ Press **TARE** and current setting will be displayed.
- ⇒ Use the navigation buttons to enter the desired minimum weight, see chapter 3.1.1 „Numeric input“.
- ⇒ Press **ON/OFF** repeatedly or for 3 sec., the balance will return into weighing mode

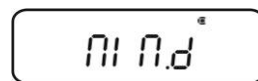
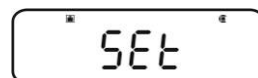
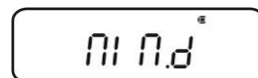
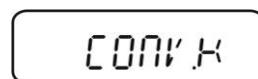

## 10.8 Change readability (1D/10D)

### Call up menu

⇒ In weighing mode press the **MENU** button twice

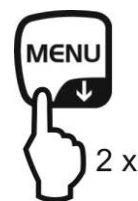

### Select menu item

- ⇒ Press the navigation buttons (↓ ↑) repeatedly until „**TOOLS**“ is displayed.
- ⇒ Confirm with **PRINT**
- ⇒ Press the navigation buttons (↓ ↑) repeatedly until „**TARGET**“ is displayed.
- ⇒ Confirm with **PRINT**
- ⇒ Press the navigation buttons (↓ ↑) repeatedly until „**PARAM.W**“ is displayed.
- ⇒ Confirm with **PRINT**
- ⇒ Press the navigation buttons (↓ ↑) repeatedly until „**CHG.MIN**“ is displayed.
- ⇒ Confirm with **PRINT**

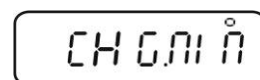

### Change readability from 1D to 10 D

1. Use the navigation buttons (↓ ↑) to select „10 D“.
2. Confirm with **TARE**. The current setting is marked by the stability display (→).
3. Press **ON/OFF** repeatedly or for 3 sec., the balance will return into weighing mode

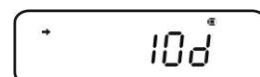
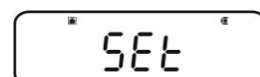
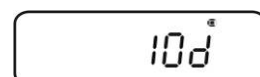
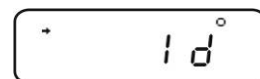

In order to reset readability to 1D, repeat step 1 – 3 accordingly for 1D.

## 10.9 Display decimal dot as point or comma

### Call up menu

⇒ In weighing mode press the **MENU** button twice

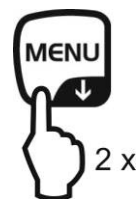

### Select menu item

⇒ Press the navigation buttons (↓ ↑) repeatedly until „**TOOLS**“ is displayed.

⇒ Confirm with **PRINT**

⇒ Press the navigation buttons (↓ ↑) repeatedly until „**SYSTEM**“ is displayed.

⇒ Confirm with **PRINT**

⇒ Press the navigation buttons (↓ ↑) repeatedly until „**POINT**“ is displayed.

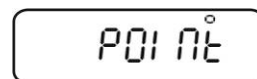

### Selection point/comma

⇒ Acknowledge using **PRINT**, the current setting is displayed.

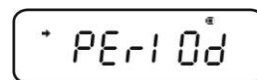

⇒ Select the desired adjustment using the navigation keys (↓ ↑)

**PERIOD:** Decimal dot is displayed as a point

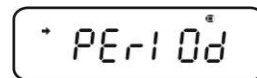

**COMMA** Decimal dot is displayed as a comma



⇒ Confirm with **TARE**. The current setting is marked by the stability display (→).

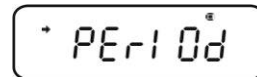
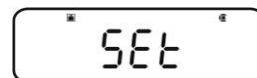

### Return to weighing mode

⇒ Press **ON/OFF** repeatedly or for 3 sec.









## 11 Menu

To adapt the behaviour of the balance to your requirements, go to the menu. Usually the default setting of the menu is such that you do not need to make any changes. If you encounter special conditions of use, go to the menu in order to set your balance according to your individual requirements.

### Menu structure:

Menu designation	Invoke menu	Explanation
Main Menu	 2 x	Main menu
Calibration Menu	 3 sec.	Adjustment
Zero / tare Menu	 3 sec.	Set to zero/taring
Data Output Menu	 3 sec.	Data output
Unit setting Menu	 3 sec.	Weighing Units

### 11.1 Menu symbol





After invoking the menu, the menu symbol [☉] will appear. The arrangement depends on the navigation in the menu.

Symbol arrangement	Explanation
Arrangement filled inside ☉	Shows the current setting
Circular arch left/right	Higher or lower menu level selectable
Circular arch top / bottom	Further selectable menu settings

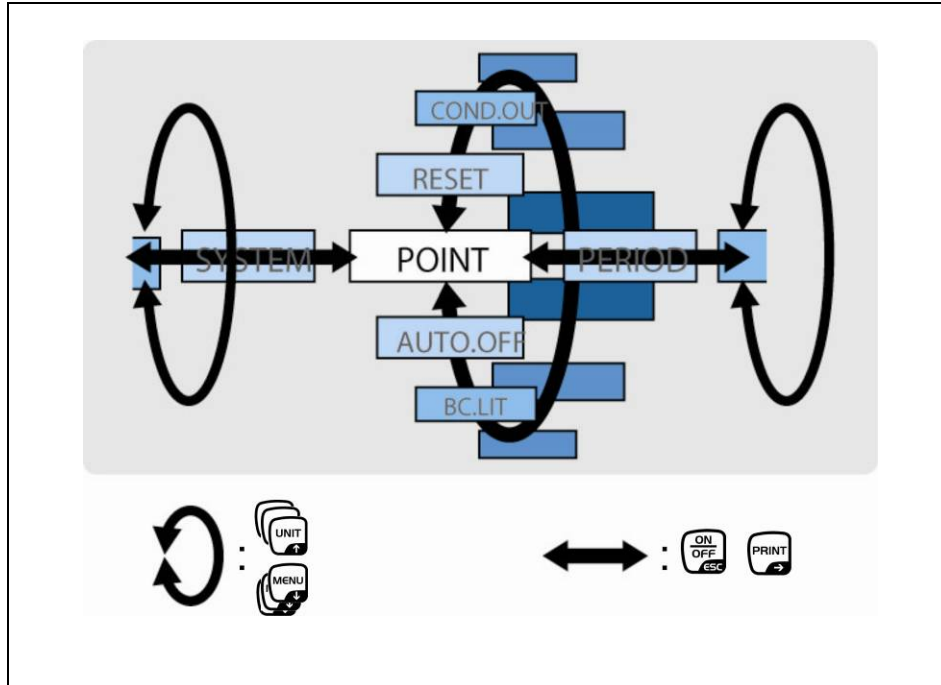
## 11.2 Navigation in the menu

- How to invoke a menu, see chpt. 11
- Menu structure



	<ul style="list-style-type: none"> <li>• Select and pass through menu items to bottom (↓).</li> <li>• Select setting within one function</li> </ul>
	<ul style="list-style-type: none"> <li>• Select and pass through menu items to top (↑).</li> <li>• Select setting within one function</li> </ul>
	<ul style="list-style-type: none"> <li>• After selecting the function in the display via the navigation buttons (↓ ↑), the change is invoked by pressing the TARE key.</li> <li>• Confirm and store the setting momentarily appearing on the display by actuating the TARE key. The stability display → shows the present setting for the function.</li> </ul>
	<ul style="list-style-type: none"> <li>• Selecting a menu item to the right (→).</li> </ul>
	<ul style="list-style-type: none"> <li>• Selecting a menu item to the left.</li> <li>• Leaving the function</li> </ul> <p>Press shortly the ON/OFF key: Back to previous menu.</p> <p>Long actuation of ON/OFF key: Back to weighing mode.</p>

# 11.3 Menu overview

See also the attached menu map

## Menu Map Sheet

Press **SEARCH** or **SEARCH** to search for the menu option.

Press **SEARCH** to proceed to the next menu option.

Press **SEARCH** to confirm.

Press **SEARCH** to return to the previous menu option.

\* The default settings (settings when the menu is reset)

### Main Menu

Weight display

**MENU** 2 x

- STAND**: General weighing mode
- POURING**: Pouring mode
- WTN**: **WTN-U** | **WTN-** | **WTN-U**
- ZTFC**: Zero tracking function
- APLFUNC**: Application function mode
  - PCS**: Piece counting
  - SAMPLE**: Item number **1-9**
  - PERCENT**: Percentage weighing
  - SAMPLE**: 100% reference
  - OPTION**: Specific percentage reference
  - FORMULA**: Formulation
- TOOLS**: Other functions
  - TARGET**: Target value
  - TG-PL**: Target value
  - LTU-PL**: Permissible range
  - CHECK.H**: Checkweighing mode
    - CH-PRNG**: Checkweighing range upper limit
    - HLIM**: Pass range upper limit
    - LOLIM**: Pass range lower limit
    - LN-PRNG**: Checkweighing range lower limit
  - PARAM.H**: Weighing parameters
    - STABH**: Stability mark
    - FAST**: Fast
    - STABD**: Stability detection range
    - 0.5D** | **1D** | **5D** | **10D** | **50D** | **100D**
  - SYSTEM**: System
    - POINT**: Decimal point indication
    - PERIOD**: Period
    - COMMA**: Comma
    - AUTOOFF**: Auto power-off
    - START**: Start display
    - AUTO**: Weighing mode
    - SEMAUTO**: OFF display
    - MANU**: All segments lit
    - BLTID**: Balance ID
    - PASSWORD**: Password
    - CONROUT**: Menu settings output
    - RESET**: Menu reset

### Data Output Menu

Weight display

**PRINT** 3 sec.

**WTN**: **WTN-U** | **WTN-** | **WTN-U**

**APLAPPN**: Application output

**AUTOAPPN**: Auto print function

**L.D.**: On Ld

**L.D.L.**: On -Ld

**L.D.L.?**: On OLd

**L.D.L.**: On -OLd

**L.D.O.**: On OK

**Z.PCT**: Zero return judgment

**PCT.0**: Zero or negative value

**PCT.50**: 50%

**SEOPPN**: Continuous output function

**MANU**: Key operation

**NOFIL**: No filter

**PRINTF**: Output timing change function

**SOON**

**COMSET**: Communication settings

**MODE.1** | **MODE.2** | **MODE.3** | **MODE.4** | **MODE.5**: Standard settings (MODE1 - MODE5)

**MODE.U**: User-specified settings

**BPS**: Baud rate

**300** | **600** | **1200** | **2400** | **4800** | **9600** | **19.2K** | **38.4K**

**PARITY**: Parity

**PHONE**: None

**PODD**: Odd

**PEVEN**: Even

**STOP**: Stop bit

**S.1**: 1 bit

**S.2**: 2 bits

**HANDSHK**: Handshake

**HS.OFF**: None

**HS.HW**: Hardware

**HS.SW**: Software

**HS.TIM**: Timer

**INFOFN**: Data format

**IF.1**: Data format 1

**IF.2**: Data format 2

**IF.3**: Data format 3

**IF.4**: Data format 4

**IF.FRE**: Free format

**IF.HEAD**: Not documented

**IF.LEN**: Not documented

**DELIM**: Delimiter

**CR**: CR

**LF**: LF

**CR+LF**: CR+LF

**COMMA**: Comma

**WTN**: **WTN-U** | **WTN-** | **WTN-U**

### Unit setting menu

Weight display

**UNIT** 3 sec.

**UNIT-g** | **UNIT-mg** | **UNIT-kg** | **UNIT-ct**

Other units cannot be selected in some countries due to legal restrictions.

#1: kg cannot be selected.

**UNIT-U**: User-specified units

**CONV.F**: Conversion factors

### Calibration menu

Weight display

**CAL** 3 sec.

**CAL-E**: Calibration (Span calibration using standard weight)

**CAL**: Calibration (Span calibration using the reference weight)

**GLP.OUTPUT**: GLP output function

**PCAL**: Not documented

### Zero / tare menu

Weight display

**TARE** 3 sec.

**ZTFC**: Zero tracking function

**ATARE**: Auto tare function

**ASEZO**: Auto zero function

**TARE.F**: Zero / tare timing change function

**SOON**

## 11.4 Resetting the menu

This will return all the settings to factory setting. The reference value stored in previous use of piece counting or percentage conversion will also be cleared. Factory settings are marked by a "\*" in the menu oversight.

### Call up menu

⇒ In weighing mode press the **MENU** button twice



### Select menu item

- ⇒ Press the navigation buttons (↓ ↑) repeatedly until „**TOOLS**“ is displayed.
- ⇒ Confirm with **PRINT**
- ⇒ Press the navigation buttons (↓ ↑) repeatedly until „**SYSTEM**“ is displayed.
- ⇒ Confirm with **PRINT**
- ⇒ Press the navigation buttons (↓ ↑) repeatedly until „**RESET**“ is displayed.

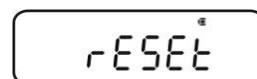

### Resetting the menu

- ⇒ Confirm with **TARE**.
- ⇒ Confirm OK inquiry by pressing **TARE**, the password inquiry will be shown.
- ⇒ Use the navigation keys (↓ ↑) to enter the password see chpt. 3.1.1 „Numeric input“.
  - ☞ Standard password (factory setting): „9999“.
  - ☞ Change password see chpt. 11.5.1
- ⇒ Confirm with **TARE**. The balance will be reset to factory setting and automatically returns into the weighing mode.

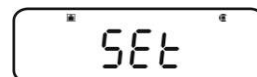
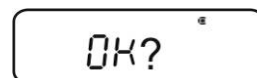

## 11.5 Menu Lock

The menu setting operations can be locked so that the settings cannot be inadvertently changed. This menu lock is set with the following procedure.

### Either

⇒ Switch-on power supply of the balance and wait until „OFF“ is displayed

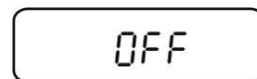

or

### or

⇒ Set balance into stand-by mode, see chpt. 10.2

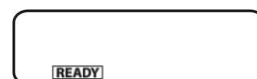

### Select menu item

1. Press **MENU** for 3 sec., the password inquiry appears.



2. Use the navigation keys (↓ ↑) to enter the password see chpt. 3.1.1 „Numeric input“.

☞ Standard password (factory setting): „9999“.

☞ Change password, see following chapter

☞ If a wrong password is entered, „ERR N“ will appear. Restart with step 1.

3. Confirm with **TARE**. The menu lock is enabled, the symbol  is activated. This is followed by a reappearance of "oFF" or **READY**.



⇒ In weighing mode the symbol  shows the menu lock.



⇒ If a menu item selection is attempted in locked status, the message “**LOCKED**” appears and the menu selection is not allowed. To deactivate menu disabled, follow the sequence of operations below:

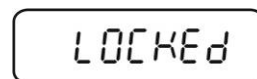

### Remove the menu lock

⇒ With indication “oFF” or „**READY**“, repeat step 1 – 3

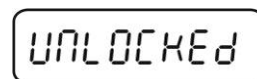

## 11.5.1 Change password



Standard password (factory setting): „9999“

### Call up menu

⇒ In weighing mode press the **MENU** button twice

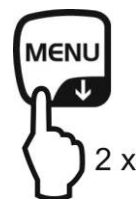

### Select menu item

- ⇒ Press the navigation buttons (↓ ↑) repeatedly until „**TOOLS**“ is displayed.
- ⇒ Confirm with **PRINT**
- ⇒ Press the navigation buttons (↓ ↑) repeatedly until „**SYSTEM**“ is displayed.
- ⇒ Confirm with **PRINT**
- ⇒ Press the navigation buttons (↓ ↑) repeatedly until „**PASS.WRD**“ is displayed.



### Change password

- ⇒ Confirm with **TARE**.
- ⇒ Use the navigation keys (↓ ↑) to enter the currently set password  
see chpt. 3.1.1 „Numeric input“.
- ⇒ Confirm with **TARE**. When „**OK**“ appears, the password input has been correct, if „**ERR N**“ appears, it was wrong. In this case repeat the input with the correct password.
- ⇒ Use the navigation keys (↓ ↑) to enter the new password  
„Numeric input“ see chpt. 3.1.1.
- ⇒ Confirm with **TARE**.
- ⇒ Confirm again with **TARE** (or discard by **ON/OFF**).

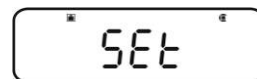
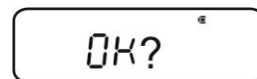
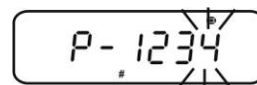
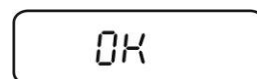
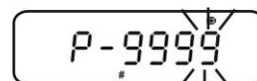

### Return to weighing mode

⇒ Press **ON/OFF** repeatedly or for 3 sec.



## 11.6 Log menu settings

When an optional printer is connected, a list of the current menu settings can be printed out.

 Data output, see chpt. 16

### Call up menu

⇒ In weighing mode press the **MENU** button twice

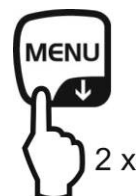

### Select menu item

- ⇒ Press the navigation buttons (↓ ↑) repeatedly until „**TOOLS**“ is displayed.
- ⇒ Confirm with **PRINT**
- ⇒ Press the navigation buttons (↓ ↑) repeatedly until „**SYSTEM**“ is displayed.
- ⇒ Confirm with **PRINT**
- ⇒ Press the navigation buttons (↓ ↑) repeatedly until „**COND.OUT**“ is displayed.

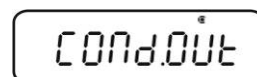

### Activate menu item

- ⇒ Confirm with **TARE**.
- ⇒ Confirm OK inquiry using **TARE**.
- ⇒ Confirm with **TARE**. The printout is started, the symbol  is displayed.

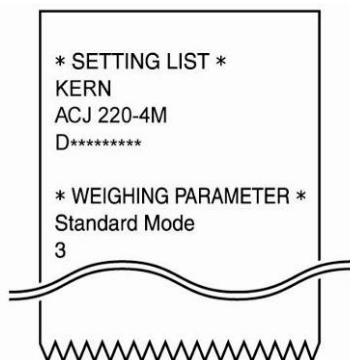
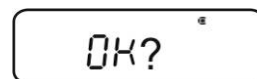

The balance returns automatically into weighing mode.



## 12 Zero / tare menu (zeroing and taring functions)

Selectable functions:

### 1. Zero tracking function

 see chpt 12.1

This function is used to correct automatically small weight variations which appear directly after switching-on.



In the event that small quantities are removed or added to the material to be weighed, incorrect weighing results can be displayed due to the “stability compensation“ in the balance. (e.g. slow flow of liquids from a container placed on the balance, evaporating processes).

When apportioning involves small variations of weight, it is advisable to switch off this function.

### 2. Auto zero function

 see chpt 12.2

This function is used to correct automatically small weight variations which appear after a measurement (e.g. soiled weighing plate) after the stability display.

### 3. Auto tare function

 see chpt 12.3

After data output an automatic taring is carried out

### 4. Zero / tare timing change function

 see chpt 12.4

Selectable if the balance tares or gets set to zero before or after indication of the stability mark.



## 12.1 Zero tracking function

**i** The zero tracking function „**A.ZERO**“ is turned-on by factory.

### 1. Check menu setting



Zero tracking symbol	Zero tracking function
is displayed	switched on
is not displayed	switched off

### 2. Call function

⇒ In weighing mode press **TARE** for 3 sec. and if necessary press repeatedly the navigation buttons (↓ ↑). until „**Z.TRC**“ is displayed. The current setting is marked by the stability display (→).

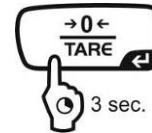

With stability display (→)      Function turned on



Without stability display (→)      Function switched off



### 3. Enable/disable function

⇒ Press **TARE**

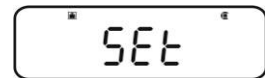

### 4. Return to weighing mode

⇒ Press **ON/OFF** repeatedly or for 3 sec.



## 12.2 Auto zero function

**i** The auto zero function is not available when formula mode is enabled (see chapter 14.3).

### 1. Call up menu

⇒ Press **TARE** for 3 sec. in weighing mode.

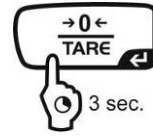

### 2. Select function

⇒ Press the navigation buttons (↓ ↑) repeatedly until „**A.ZERO**“ is displayed. The current setting is marked by the stability display (→).



Further steps depend on the desired setting:

Stability display (→)	Function		set/update	cancel
yes 	ON	➔	Press <b>PRINT</b> and continue with step 3.	Press <b>TARE</b> and continue with step 4.
no 	off	➔	Press <b>TARE</b> and continue with step 3.	continue with step 4.

### 3. Define zero range

⇒ Press **TARE**

⇒ Use the navigation keys (↓ ↑) to enter the zero range see chpt. 3.1.1 „Numeric input“.

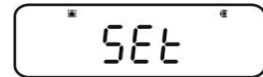

### 4. Return to weighing mode

⇒ Press **ON/OFF** repeatedly or for 3 sec.

**i** When entering the zero range observe the currently set weighing unit. If the weighing unit is changed at a later moment, the zero range must be adapted to the new weighing unit (step 3.).



Upper limit zero range: 99 d (in the displayed weighing unit)

Lower limit zero range: 1d (in the displayed weighing unit)

Example for a balance d = 0.0001 g

Unit	Lower limit	Upper limit
g	0.0001 g	0.0099 g
ct	0.001 ct	0.099 ct

## 12.3 Auto Tare function

### 1. Call up menu

⇒ Press **TARE** for 3 sec. in weighing mode.

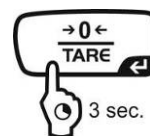

### 2. Select function

⇒ Press the navigation buttons (↓ ↑) repeatedly until „**A.TARE**“ is displayed. The current setting is marked by the stability display (→).

With stability display (→)      Function turned on



Without stability display (→)      Function switched off



### 3. Enable/disable function

⇒ Press **TARE**

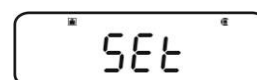

### 4. Return to weighing mode

⇒ Press **ON/OFF** repeatedly or for 3 sec.



## 12.4 Zero / tare timing change function

**i** The zero / tare timing change function can be switched-on, when the „Auto zero“ and the „Auto tare“ function are enabled.

### 1. Call up menu

⇒ Press **TARE** for 3 sec. in weighing mode.



### 2. Select function

⇒ Press the navigation buttons (↓ ↑) repeatedly until „**TARE.F**“ is displayed.



⇒ Confirm with **PRINT**. The current setting is marked by the stability display (→).

With stability display (→)      Function turned on



Without stability display (→)      Function switched off

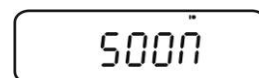

### 3. Enable/disable function

⇒ Press **TARE**

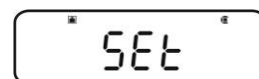

### 4. Return to weighing mode

⇒ Press **ON/OFF** repeatedly or for 3 sec.



### 13 Settings for Stability and Response

Exists the possibility to tune the stability of the display and the degree of reaction of the balance to the requirements of certain applications or the environmental conditions.

Most measurements can be carried out using default settings, that is, standard mode. In standard weighing mode, stability and reaction have the same priority. For certain applications such as e.g. dosage do use the dosing mode (pouring mode). In dosing mode the reaction degree has the higher priority.

Beside the selection standard / dosing mode the stability of the display and the reaction degree of the balance can additionally adapted in the menu.

Please note that data processing for greater stability generally slows the response and processing for higher response reduces stability.

#### 13.1 Stability and reaction settings via „Easy Setting display“ (without invoking menu)

- In weighing mode press **MENU** shortly. The easy setting display [ R L L L S ] flashes.
- When the display is flashing, set stability or reaction via **UNIT** or **PRINT** as described in the following.

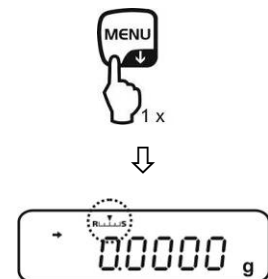

Priority on reaction



Priority on stability

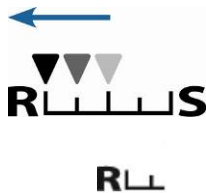

Easy setting display

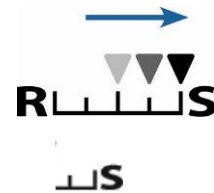

Operation



Every time the button is hit, reaction will increase

Every time the button is hit, stability will increase

**i** The easy setting display flashes for a short time. Inputs are only possible within this time. Using **ON/OFF** the flashing Easy setting display can be switched off.

## 13.2 Selection weighing / dosing mode

### Call-up weighing mode:

This is the default setting. Use this mode, when neither stability nor reaction time must be increased or reduced.

#### Call up menu

⇒ In weighing mode press the **MENU** button twice

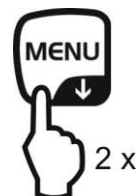

#### Select menu item

⇒ Press the navigation buttons (↓ ↑) repeatedly until „**STAND**“ is displayed.

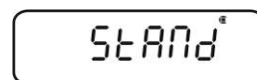

⇒ Confirm with **TARE**. The balance returns automatically into weighing mode.

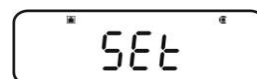

### Call-up dosing mode:

Use this function if you wish to increase display speed, e.g. during apportioning. However, please note that the balance is very susceptible to ambience conditions.

#### Call up menu

⇒ In weighing mode press the **MENU** button twice

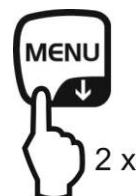

#### Select menu item

⇒ Press the navigation buttons (↓ ↑) repeatedly until „**POURING**“ is displayed.



⇒ Confirm with **TARE**. From here on the balance is in dosing mode (pouring mode), symbolised by the indicator .

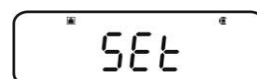

### 13.3 Standstill width

If the stability display lights up (➔), the weighing result will be stable within the range indicated by the standstill width.

#### Set range for stability determination:

##### Call up menu

⇒ In weighing mode press the **MENU** button twice

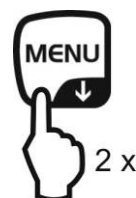

##### Select menu item

⇒ Press the navigation buttons (↓ ↑) repeatedly until „**TOOLS**“ is displayed.

⇒ Confirm with **PRINT**

⇒ Press the navigation buttons (↓ ↑) repeatedly until „**PARAMW**“ is displayed.

⇒ Confirm with **PRINT**

⇒ Press the navigation buttons (↓ ↑) repeatedly until „**BAND**“ is displayed.



##### Set range

⇒ Acknowledge using **PRINT**, the current setting is displayed.

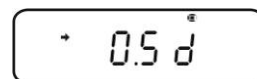

⇒ Use the navigation buttons (↓ ↑) to select the desired setting (0.5d, 1d, 10d, 50d, 100d, 1000d can be selected).

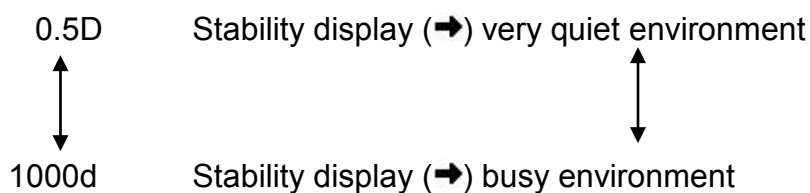
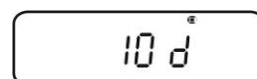

⇒ Confirm with **TARE**. The current setting is marked by the stability display (➔).

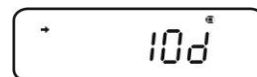
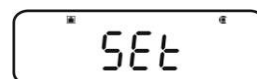

##### Return to weighing mode

⇒ Press **ON/OFF** repeatedly or for 3 sec.



## Set reaction time:

### Call up menu

⇒ In weighing mode press the **MENU** button twice

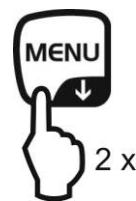

### Select menu item

⇒ Press the navigation buttons (↓ ↑) repeatedly until „**TOOLS**“ is displayed.

⇒ Confirm with **PRINT**

⇒ Press the navigation buttons (↓ ↑) repeatedly until „**PARAMW**“ is displayed.

⇒ Confirm with **PRINT**

⇒ Press the navigation buttons (↓ ↑) repeatedly until „**STB.Mk**“ is displayed.



### Set reaction time

⇒ Confirm with **PRINT**. The current setting is marked by the stability display (→).

with (→) Stability display appears faster, but with less exactness.

without (→) Default



⇒ Confirm with **TARE**. The current setting is marked by the stability display (→).

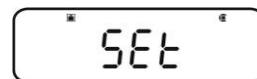

### Return to weighing mode

⇒ Press **ON/OFF** repeatedly or for 3 sec.





## 14 Application Functions



- The application functions can be combined with the check weighing or target function (see chpt. 14).
- The balance starts in the mode, in which it has been switched off.
- For switching over between application and weighing mode, press **MENU** for 3 sec.

### 14.1 Parts counting

With parts counting you can either count parts into a container or remove parts from a container. To count a greater number of parts the average weight per part has to be determined with a small quantity (reference quantity). The larger the reference quantity, the higher the counting exactness. High reference must be selected for small parts or parts with considerably different sizes.

#### 1. Enable function and set reference

##### Call up menu

⇒ In weighing mode press the **MENU** button twice

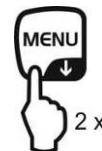

##### Select piece counting mode

⇒ Press the navigation buttons (↓ ↑) repeatedly until „**APL.FUNC**“ is displayed.

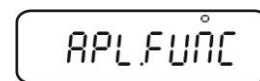

⇒ Confirm with **PRINT**

⇒ Press the navigation buttons (↓ ↑) repeatedly until „**PCS**“ is displayed.

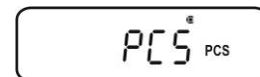

⇒ Press **TARE**. The display shows the currently set memory location.

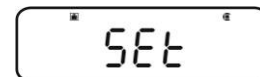

##### Enter memory location for reference

⇒ The balance offers the possibility to store five different piece weights at the same time.



⇒ Press the navigation buttons (↓ ↑) repeatedly until the desired memory location **12345** is displayed, then press **TARE**.

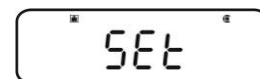

Display, if no piece weight is stored

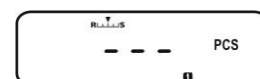

Display, if a piece weight is stored

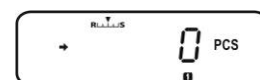

### Set reference

- ⇒ Place an empty container on the balance and tare it by pressing **TARE**.
- ⇒ Press **MENU** twice.
- ⇒ Press the navigation buttons (↓ ↑) repeatedly until the desired reference quantity is displayed (possible reference quantities 5, 10, 20, 50, 100).  
Use **MENU** to scroll forward.  
Use **UNIT** to scroll backward.
- ⇒ Fill number of pieces into the container according to the selected reference quantity.
- ⇒ Wait for the stability display (→), then confirm by pressing **TARE**. The balance determines the average piece weight.  
From here on the appliance is in piece counting mode and counts all pieces which are on the weighing plate.

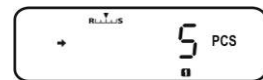
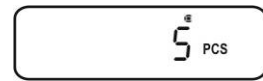

### 2. Switching over between piece counting and weighing mode

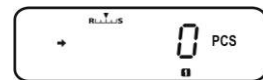
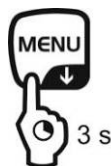

### 3. Count the items

#### Call-up the piece weight stored in piece counting mode

- ⇒ Every time **UNIT** is pressed (approx. for 3 sec.), the next memory location [ 1 2 3 4 5 ] is called up.

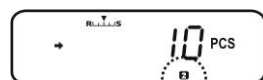
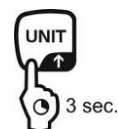

**i** If under the indicated memory location no reference is stored, [- -] will be displayed.

- ⇒ Place an empty container on the balance and tare it by pressing **TARE**.
- ⇒ Fill weighing goods into the container and read the piece quantity.

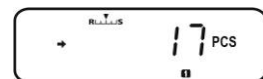
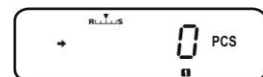

⇒ Or count more pieces

or



The menu item to change the stored reference is called up, the currently set reference quantity is displayed.

☞ see „4. Change or add piece weight“



The stored piece weight is displayed in grams, marked by the symbol **\***. Using **PRINT** the reference weight (UW= Unit weight) can be edited when a printer is connected.

e.g.: UW = 1.0001

To go back to piece counting display press **UNIT** anew.



Switching over between piece counting and weighing mode

#### 4. Change or add piece weight

##### In piece counting mode call-up the desired memory location

⇒ Every time **UNIT** is pressed (approx. for 3 sec.), the next memory location [ **1 2 3 4 5** ] is called up.

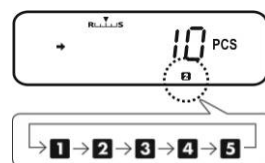

##### Change or add piece weight

⇒ Place an empty container on the balance and tare it by pressing **TARE**.

⇒ Press **MENU** twice, the currently set reference quantity is displayed.

⇒ Press the navigation buttons (↓ ↑) repeatedly until the desired reference quantity is displayed (possible reference quantities 5, 10, 20, 50, 100).

Use **MENU** to scroll forward.  
Use **UNIT** to scroll backward.

⇒ Fill number of pieces into the container according to the selected reference quantity.

⇒ Wait for the stability display (→), then confirm by pressing **TARE**.

The balance is now in parts counting mode and counts all units on the weighing plate.

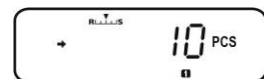
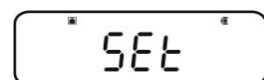
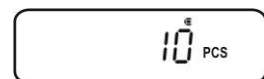
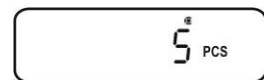

## 14.2 Percent determination

Percent weighing allows to display weight in percent, in relation to a reference weight.

The balance offers two possibilities:

1. **Reference = 100 %**
2. **Reference = defined by user**

### Call up menu

⇒ In weighing mode press the **MENU** button twice

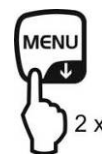

### Select percent weighing mode

⇒ Press the navigation buttons (↓ ↑) repeatedly until „**APL.FUNC**“ is displayed.

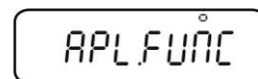

⇒ Confirm with **PRINT**

⇒ Press the navigation buttons (↓ ↑) repeatedly until „**PERCENT**“ is displayed.



Further steps:

- ☞ Reference weight = 100 %, see chpt. 14.2.1
- ☞ Reference weight = XX %, see chpt. 14.2.2

### 14.2.1 Reference weight = 100 %

⇒ Select percent weighing mode, see chpt. 14.2

⇒ Press **TARE**.

⇒ If necessary, press the navigation buttons (↓ ↑) repeatedly until „**SAMPLE**“ is displayed.

⇒ Press **TARE**.

Display, if no reference weight is stored

Display, if a reference weight is stored

#### Set reference

⇒ If necessary, place an empty container on the balance and tare it by pressing **TARE**.

⇒ Press **MENU** twice.

Put a reference weight which corresponds to 100 %.  
(Minimum weight: Readability d x 100)

⇒ Wait for the stability display (→), then confirm by pressing **TARE**.

From here on the weight of the sample is displayed in percentage in terms of the reference weight, see chpt. 13.2.3.

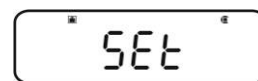
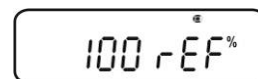
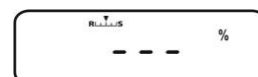
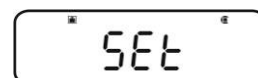
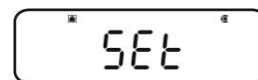

## 14.2.2 User-defined reference

⇒ Select percent weighing mode, see chpt. 13.2

⇒ Press **TARE**.

⇒ If necessary, press the navigation buttons (↓ ↑) repeatedly until „**OPTION**“ is displayed.

⇒ Press **TARE**.

Display, if no reference is stored

Display, if a reference is stored

### Set reference

⇒ If necessary, place an empty container on the balance and tare it by pressing **TARE**.

⇒ Press **MENU** twice.

⇒ Press **PRINT** and current setting will be displayed. Enter a percentage of your choice via the navigation buttons, see chpt. 3.1.1 „Numeric input“

⇒ Put a reference weight which corresponds to the entered percent value.

⇒ Wait for the stability display (→), then confirm by pressing **TARE**.  
The display symbol [%] characterises the percentage determination with user-defined reference value.

From here on the weight of the sample is displayed in percentage in terms of the reference weight, see chpt. 14.2.3.

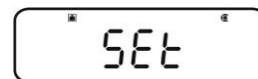
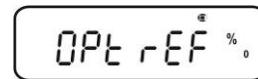
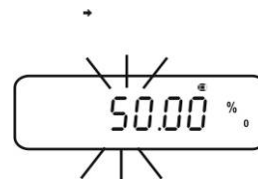
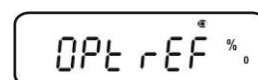
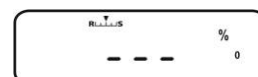
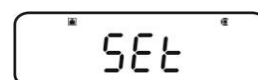
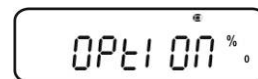
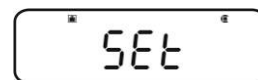

### 14.2.3 Percent determination



- ⇒ In weighing mode press **MENU** for 3 sec., the currently set percentage determination mode is displayed.
- ⇒ Place an empty container on the balance and tare it by pressing **TARE**.
- ⇒ Place goods to be weighed on balance. The weight of the sample is displayed in percentage in terms of the reference weight.
- ⇒ Either carry out more percent weighing



or

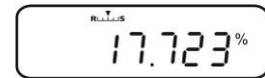

or



The menu item to change the stored reference appears.

☞ see chpt. 14.2.2 / 14.2.3 „Set reference“



The stored reference weight is displayed in grams, marked by the symbol **\***. Use **PRINT** to edit the weight value of the reference value when a printer is connected.

Back to percent display, press **UNIT** anew.



Switching over between percentage determination and weighing mode

### 14.3 Formula mode

The formula function allows to add on various components of a mixture. For check purpose, the weight of all components (CMP001, (CMP002 etc.), as well as the total weight (TOTAL) can be printed out. The balance works with a separated memory for the weight of the weighing container and of the formula components.

**i** In formula mode the „Auto zero“ function is not active (see chpt. 12.2).

#### 1. Connect printer (see chpt. 15 „Data output“)

#### 2. Call up menu

⇒ In weighing mode press the **MENU** button twice

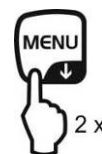

#### 3. Select formula mode

⇒ Press the navigation buttons (↓ ↑) repeatedly until „**APL.FUNC**“ is displayed.

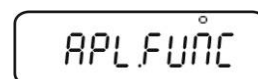

⇒ Confirm with **PRINT**

⇒ Press the navigation buttons (↓ ↑) repeatedly until „**FORMULA**“ is displayed. The formula symbol [  ] appears.



⇒ Press **TARE**. The indicator **READY** is displayed, from here on the balance is in formula mode.

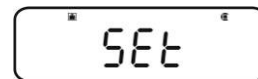

Enable the edition „component no.“(see chpt. 14.3.1) and „Total“ (see chpt. 14.3.2).



#### 4. Weighing components

If necessary, place an empty container on the balance and tare it by pressing **TARE**.

⇒ Press **PRINT**, the symbol **READY** goes out. When the GLP function (see chpt. 8.3) is activated, the headline will be printed.

⇒ Weigh first component.



⇒ Press **PRINT**.

When standstill control (→) is completed, the weighing value of the first component (CMP001) is issued to the optional printer. The displayed value is added into the total adding memory. This is followed by the automatic taring, the symbol **[NET]** is displayed.





⇒ Weigh further components in the same way

**i** During formulation weighing can be displayed at any time by pressing **MENU** (for 3 sec.).

### 5. Complete formulation process

⇒ Press **ON/OFF**. When the symbol [G] is displayed, the total weight (**TOTAL**) of all components is displayed and edited to the printer.



⇒ When the symbol **READY** is displayed, the balance is ready for further measurements.



### 6. Return to weighing mode

⇒ Press **ON/OFF** for 3 sec.



### Printout example „GLP ON“ (KERN YKB-01N):

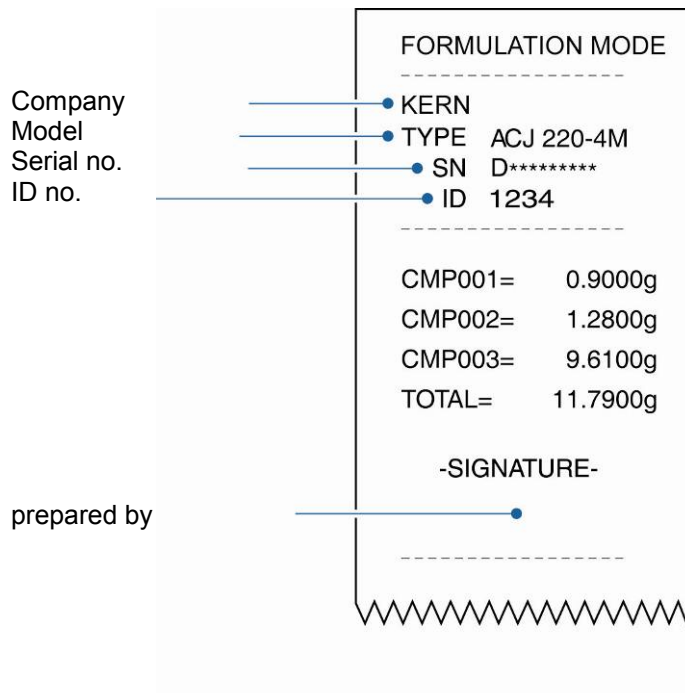

### 14.3.1 Enable edition „component no.“

- ⇒ Select formula mode, see chpt. 14.3
- ⇒ When the symbol **READY** appears, press the **MENU** button twice.
- ⇒ Press the navigation buttons (↓ ↑) repeatedly until „ELM.NUM“ is displayed.
- ⇒ Confirm with **PRINT**. The current setting is marked by the stability display (→).



with (→) Edition „component no.“  
(e.g. CMP001)



without (→) No edition „component no.“



- ⇒ Change using **TARE**.

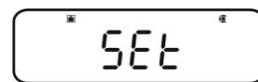

#### Back to formula mode

- ⇒ Press **ON/OFF** repeatedly or for 3 sec.



#### Printout examples (KERN YKB-01N):

Function ELM.NUM enabled



FORMULATION MODE	
CMP001=	0.5361 g
CMP002=	0.5422 g
CMP003=	0.4488 g
TOTAL=	1.5271 g

Function ELM.NUM disabled



FORMULATION MODE	
	0.5361 g
	0.5422 g
	0.4488 g
TOTAL=	1.5271 g

### 14.3.2 Enable issue „TOTAL“

- ⇒ Select formula mode, see chpt. 14.3
- ⇒ When the symbol **READY** appears, press the **MENU** button twice.



- ⇒ Press the navigation buttons (↓ ↑) repeatedly until „TOTAL“ is displayed.
- ⇒ Confirm with **PRINT**. The current setting is marked by the stability display (→).

with (→) Issue „TOTAL“



without (→) No issue „TOTAL“



- ⇒ Change using **TARE**.



#### Back to formula mode

- ⇒ Press **ON/OFF** repeatedly or for 3 sec.



#### Printout examples (KERN YKB-01N):

Function TOTAL enabled

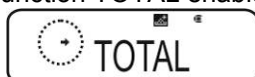

FORMULATION MODE	
CMP001=	0.5361 g
CMP002=	0.5422 g
CMP003=	0.4488 g
TOTAL	1.5271 g

Function TOTAL disabled



FORMULATION MODE	
CMP001=	0.5361 g
CMP002=	0.5422 g
CMP003=	0.4488 g

## 15 Check weighing and target mode (check and target weighing)

- i**
- The check weighing or target mode can be applied for the application functions (see chpt. 14).
  - The balance starts in the mode, in which it has been switched off.

### 15.1 Check weighing

In many cases not the nominal value of the weighed goods is the decisive parameter, but the deviation from this nominal value. Such applications are for example the weight check of equivalent packages or the process check of parts in a fabrication process.

The indicators **HI**, **OK** or **LO** in the display show, where the weighed goods are located within the tolerance range.

These indicators are only functioning in check weighing or in target mode, otherwise they cannot be seen.

The indicators provide the following information

Condition	Grading	Indicator
$OVR.RNG < \text{sample weight}$	Beyond tolerance limit	No indicator
$HI.LIM < \text{sample weight} \leq OVR.RNG$	Upper tolerance limit	<b>HI</b>
$LO.LIM \leq \text{sample weight} \leq HI.LM$	Inside tolerance range	<b>OK</b>
$UND.RG \leq \text{sample weight} < LO.LIM$	Lower tolerance limit	<b>LO</b>
$\text{Sample weight} < UND.RG$	Beyond tolerance limit	No indicator

## 0. Call up menu

⇒ In weighing mode press the **MENU** button twice



## 1. Select function

⇒ Press the navigation buttons (↓ ↑) repeatedly until „**TOOLS**“ is displayed.

⇒ Confirm with **PRINT**

⇒ Press the navigation buttons (↓ ↑) repeatedly until „**CHECK.W**“ is displayed. The current setting is marked by the stability display (→).



Further steps depend on the desired setting:

Stability display (→)	Function		set/update	cancel
yes 	ON	➔	Press <b>PRINT</b> and continue with step 3.	Press <b>TARE</b> and continue with step 4.
no 	off	➔	Press <b>TARE</b> and continue with step 3.	continue with step 4.

## 2. Set limit values

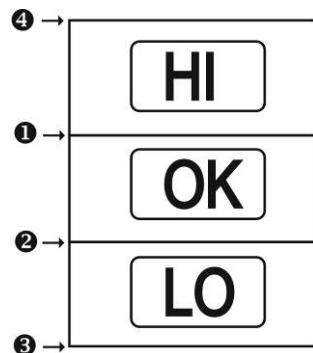

When entering the limit values ensure that the values match logically one with another, i.e. the lower limit value must not be greater than the upper one.

If not considered, the balance will adapt the limit values automatically.

➊ Press the navigation buttons (↓ ↑) repeatedly until „**HI.LIM**“ is displayed.



⇒ Press **TARE**. The current setting will be displayed.

⇒ Use the navigation buttons (↓ ↑) to enter the desired value, see chpt. 3.1.1 „Numeric input“.



⇒ Confirm with **TARE**.

② Press the navigation buttons (↓ ↑) repeatedly until „**LO.LIM**“ is displayed.

⇒ Press **TARE**. The current setting will be displayed.

⇒ Use the navigation buttons (↓ ↑) to enter the desired value, see chpt. 3.1.1 „Numeric input“.

⇒ Confirm with **TARE**.

③ Press the navigation buttons (↓ ↑) repeatedly until „**UND.RNG**“ is displayed.

⇒ Press **TARE**. The current setting will be displayed.

⇒ Use the navigation buttons (↓ ↑) to enter the desired value, see chpt. 3.1.1 „Numeric input“.

⇒ Confirm with **TARE**.

④ Press the navigation buttons (↓ ↑) repeatedly until „**OVR.RNG**“ is displayed.

⇒ Press **TARE**. The current setting will be displayed.

⇒ Use the navigation buttons (↓ ↑) to enter the desired value, see chpt. 3.1.1 „Numeric input“.

⇒ Confirm with **TARE**.

### 3. Return to weighing mode



⇒ Press **ON/OFF** repeatedly or for 3 sec.

### 4. Start tolerance control

If necessary, place an empty container on the balance and tare it by pressing **TARE**.

Place weighed goods and wait until the indicator **HI**, **OK** or **LO** appears. With the help of the indicator check if the weighed goods are under, inside or over the default tolerance

#### Example of entry:

- ❶ HI.LIM 7.0000 g
- ❷ LO.LIM 6.0000 g
- ❸ UND.RNG 5.0000 g
- ❹ OVR.RNG 8.0000 g

Sample weight < UND.RG (sample weight < 5.0000g)		<b>No indicator</b> is displayed
UND.RG ≤ sample weight < LO.LIM (sample weight 5.0000g - 5.9999g)		<b>LO</b> is displayed
LO.LIM ≤ sample weight ≤ HI.LIM (sample weight 6.0000g - 7.000g)		<b>OK</b> is displayed
HI.LIM < sample weight ≤ OVR.RNG (sample weight 7.0001g - 8.0000g)		<b>HI</b> is displayed
Sample weight > OVR.RNG (sample weight > 8.0000 g)		<b>No indicator</b> is displayed

## 15.2 Target mode

This mode e.g. is used for weighing constant liquid quantities or for assessment of missing quantities or excess quantities.

The target value is the numeric value which corresponds to the nominal quantity of the used unit. Beside the target value a tolerance value is entered. This is a numerical value which is plus/minus over or under the acceptable target value.

The indicators **HI**, **OK** or **LO** advise, when the target value is reached. These indicators are only functioning in check weighing or in target mode, otherwise they cannot be seen.

The indicators provide the following information:

Condition	Grading	Indicator
Weight more than the nominal weight and above the upper tolerance	Great difference to target value	<b>HI</b> flashes slowly
	Small difference to target value	<b>HI</b> flashes fast
Weight within tolerance (target value $\pm$ tolerance)	Target value accepted	<b>OK</b>
Weight less than nominal weight and below the lower tolerance	Small difference to target value	<b>LO</b> flashes fast
	Great difference to target value	<b>LO</b> flashes fast



### 1. Call up menu

⇒ In weighing mode press the **MENU** button twice



### 2. Select function

- ⇒ Press the navigation buttons (↓ ↑) repeatedly until „TOOLS“ is displayed.
- ⇒ Confirm with **PRINT**
- ⇒ Press the navigation buttons (↓ ↑) repeatedly until „TARGT“ is displayed. The current setting is marked by the stability display (→).



Further steps depend on the desired setting:

Stability display (→)	Function	set/update	cancel
yes 	ON	Press <b>PRINT</b> and continue with step 3.	Press <b>TARE</b> and continue with step 4.
no 	off	Press <b>TARE</b> and continue with step 3.	continue with step 4.

### 3. Set target value and tolerance

- ⇒ Press the navigation buttons (↓ ↑) repeatedly until the display to enter the target value „TG.VAL“ appears.
- ⇒ Press **TARE**. The current setting will be displayed.
- ⇒ Use the navigation buttons (↓ ↑) to enter the desired value, see chpt. 3.1.1 „Numeric input“.
- ⇒ Confirm with **TARE**.
- ⇒ Press the navigation buttons (↓ ↑) repeatedly until the display to enter the target value „LM.VAL“ appears.
- ⇒ Press **TARE**. The current setting will be displayed.
- ⇒ Use the navigation buttons (↓ ↑) to enter the desired value, see chpt. 3.1.1 „Numeric input“.

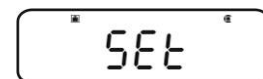

⇒ Confirm with **TARE**.

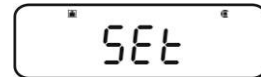

**4. Return to weighing mode**



⇒ Press **ON/OFF** repeatedly or for 3 sec.



**5. Start tolerance control**

If necessary, place an empty container on the balance and tare it by pressing **TARE**.

Place weighed goods and wait until the indicator **HI**, **OK** or **LO** appears. With the help of the indicator check if the weighed goods are under, inside or over the default tolerance

**Example of entry:**      **TG.VAL**                      100.0000 g  
    **LM.VAL**                      10.0000 g

Weight less than nominal weight and below the lower tolerance		<b>LO</b> flashes slowly
		<b>LO</b> flashes fast
Weight within tolerance [target value ± tolerance] (90.0000g – 110.000g)		<b>OK</b>
Weight more than the nominal weight and above the upper tolerance		<b>HI</b> flashes fast
		<b>HI</b> flashes slowly

## 16 Data output

The appliance interface allows a bi-directional data exchange from the balance to external devices. This data exchange is asynchronous using ASCII - Code.

The following conditions must be met to provide successful communication between the weighing balance and the printer.

- Use a suitable cable to connect the weighing balance to the interface of the printer/PC.  
**Faultless operation requires an adequate KERN interface cable (optional).**
- Communication parameters (baud rate, bits and parity) of balance and printer must match.

### 16.1 Pin connection

Due to connection of an optional **KERN** interface cable the balance is equipped with a RS232C interface.

Balance (RS-232C)	
3	TXD
2	RXD
6	DSR
5	SG
4	DTR
7	CTS
8	RTS

## 16.2 Issue functions

### 16.2.1 Automatic data output / Auto Print function

Data output ensues automatically without pressing **PRINT**, as soon as the respective output condition is fulfilled. This is defined by the menu setting.

Tab. 1:

	stable / positive	stable / negative	Stabilisation / zero display	Check weighing	
Mode 1 LD. .	✓	-	-	-	Output for stable and positive weighing value
Mode 2 LD.UL.	✓	✓	-	-	Output for stable and positive or negative weighing value.
Mode 3 LD. .Z	✓	-	✓	-	Output for stable and positive weighing value. New output only after zero display and stabilisation
Mode 4 LD.UL.Z	✓	✓	✓	-	Output for stable and positive or negative weighing value. New output only after zero display and stabilisation.
Mode 5 LD.OK .	-	-	-	✓	If the Auto Print function is connected to the check weighing function, data of stable weighing values are output with indicator display  .

#### Enable Auto Print function:

##### 1. Invoke Data Output menu

⇒ Press **PRINT** for 3 sec. in weighing mode.



##### 2. Select function



⇒ Press the navigation buttons (↓ ↑) repeatedly until „**APL.PRN**“ is displayed.

⇒ Confirm with **PRINT**

⇒ Press the navigation buttons (↓ ↑) repeatedly until „**AUTO.PRN**“ is displayed. The current setting is marked by the stability display (→).



Further steps depend on the desired setting:

Stability display (→)	Function	set/update	cancel
yes 	ON	Press <b>PRINT</b> and continue with step 3.	Press <b>TARE</b> and continue with step 5.
no 	off	Press <b>TARE</b> and continue with step 3.	continue with step 5.

### 3. Set output condition

- ⇒ Use the navigation buttons (↓ ↑) to select the desired mode, e.g. Mode 3 (details see Tab. 1)
- ⇒ Confirm with **TARE**

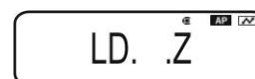

### 4. If necessary, set condition for zero display

- ⇒ Press **PRINT**
- ⇒ Select the desired adjustment using the navigation keys (↓ ↑)

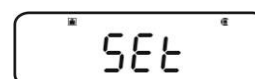

**RET.0** An other output when the display goes back to zero.

**RET.50%** An other output when the display goes back to 50% of the previous weighing value.

With selection „RET.0“



- ⇒ Confirm with **TARE**

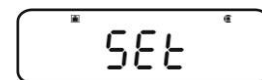

### 5. Return to weighing mode

- ⇒ Press **ON/OFF** repeatedly or for 3 s. From here on the Auto Print function is active, the indicator **AP** is displayed.



### 5. Place goods to be weighed on balance

- ⇒ If necessary, place an empty container on the balance and tare it by pressing **TARE**.
- ⇒ Place weighed goods and wait until the stability display (→) appears. The weighing value is issued automatically.

### 6. Remove the weighed good.

- ⇒ Wait until the stability (→) / zero display appears. The weighing value is issued automatically.

## 16.2.2 Continuous Output function

### 1. Invoke Data Output menu

⇒ Press **PRINT** for 3 sec. in weighing mode.



### 2. Select function

⇒ Press the navigation buttons (↓ ↑) repeatedly until „**APL.PRN**“ is displayed.

⇒ Confirm with **PRINT**

⇒ Press the navigation buttons (↓ ↑) repeatedly until „**SEQ.PRN**“ is displayed. The current setting is marked by the stability display (→).

with (→) on

without (→) off

⇒ Change using **TARE**.

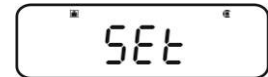

### 3. Set start/end of the continuous issue manually or automatically

⇒ Press **PRINT**

⇒ Press the navigation buttons (↓ ↑) repeatedly until „**MANU**“ is displayed. The current setting is marked by the stability display (→).

with (→) The continuous data output starts after pressing of **PRINT** and ends by pressing **ON-OFF**

without (→) The continuous data output starts automatically

⇒ Change using **TARE**

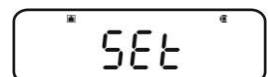

#### 4. Connect filter

⇒ Press the navigation buttons (↓ ↑) repeatedly until „**NO.FIL**“ is displayed. The current setting is marked by the stability display (➔).

with (➔) Weighing value is filtered

without (➔) Weighing value is not filtered



⇒ Change using **TARE**

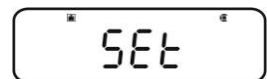

#### 5. Return to weighing mode

⇒ Press **ON/OFF** repeatedly or for 3 s.

With activated menu setting „**MANU**“ (see step 3, with ➔) the indicator **READY** will appear.



With deactivated menu setting „**MANU**“ (see step 3, without ➔) starts the continuous data output automatically, step 7 is not applied.

#### 6. Tare weighing container

⇒ If necessary, place an empty container on the balance and tare it by pressing **TARE**.

⇒ Place weighed goods and wait until the stability display (➔) appears. The weighing value is issued automatically.

#### 7. Press **PRINT** (only with menu setting „**MANU ON**“)

⇒ The continuous data output starts, the indicator **READY** goes out.

#### 8. Place goods to be weighed on balance

⇒ Every display change is continuously issued, (data issue interval approx. 100 msec).

**i** **Interrupt continuous data output**  
**ON-OFF** = interrupt  
**PRINT** = restart

### 16.2.3 Output Timing Change function

This function allows to select if the data output shall ensue with stable or instable weighing value after pressing **PRINT**.

#### 1. Invoke Data Output menu

⇒ Press **PRINT** for 3 sec. in weighing mode.



#### 2. Select function

⇒ Press the navigation buttons (↓ ↑) repeatedly until „**APL.PRN**“ is displayed.

⇒ Confirm with **PRINT**

⇒ Press the navigation buttons (↓ ↑) repeatedly until „**PRINT.F**“ is displayed.

⇒ Confirm with **PRINT**. The current setting is marked by the stability display (→).

with (→) Instantaneous data output without waiting until the stability display appears

without (→) Data output only after stability display

⇒ Change using **TARE**.



#### 3. Return to weighing mode

⇒ Press **ON/OFF** repeatedly or for 3 s.



## 16.2.4 GLP Output function / balance identification number

With the GLP Output function the printouts of weighing results are completed with a bottom row and a head line. Contents of the headline and bottom row see following printout example.

- ☞ Enable GLP Output function, see chpt. 8.3
- ☞ Enter balance identification number, see chpt. 8.4

Printout example:

KERN & Sohn GmbH	Company
TYPE ABJ 220-4NM	Model
SN WBIAB000I	Serial no.
ID 1234	Balance identification no. (see chpt. 8.4)
200.0000g	Weighing result
-SIGNATURE-	prepared by
-----	



In the ABS/ABJ\_N series it is not possible to state date and time.

### 16.3 Communication parameters

By calling-up a standard setting „**MODE 1 - MODE 5**“ all communication parameters are already preset (see chpt. 16.3.1).

The subsequent standard setting must be selected according to the printer (details see the following table).

In the menu item „**MODE U**“ all parameters can be set defined by user (see chpt. 16.3.2).

	Standard setting 1	Standard setting 2	Standard setting 3	Standard setting 4	Standard setting 5	User-defined settings	Setting for KERN – YKB-01N
Menu selection	MODE 1	MODE 2	MODE 3	MODE 4	MODE 5	MODE U	MODE U
Manufacturer	Shimadzu (Standard)	Shimadzu *	Mettler	Sartorius	A-D	-	-
Baud Rate	1200	1200	2400	1200	2400	user-defined	1200
Parity	None (8)	None (8)	Even (7)	Odd (7)	Even (7)	user-defined	None (8)
Stop bit	1	1	2	2	2	user-defined	1
Handshake	Hardware	Hardware	off	Hardware	off	user-defined	off
Data format	Shimadzu Standard	Shimadzu Standard	Mettler Standard	Sartorius Standard	A-D Standard	user-defined	DF.1
Separator	C/R	C/R	C/R + L/F	C/R + L/F	C/R + L/F	user-defined	C/R

\*only if the balance can send a feedback to the PC (without error: OK [C/R], at error NG [C/R]).

### 16.3.1 Selection of a standard setting „MODE 1 - MODE 5“

#### 1. Invoke Data Output menu

⇒ Press **PRINT** for 3 sec. in weighing mode.



#### 2. Select function

⇒ Press the navigation buttons (↓ ↑) repeatedly until „**COMM.SET**“ is displayed.



⇒ Confirm with **PRINT**

⇒ Press the navigation buttons (↓ ↑) repeatedly until the desired mode „**MODE 1 - MODE 5**“ is displayed. The current setting is marked by the stability display (→).



with (→) on



without (→) off

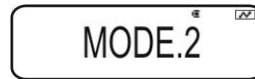

⇒ Change using **TARE**.

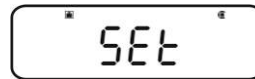

#### 3. Return to weighing mode

⇒ Press **ON/OFF** repeatedly or for 3 s.



### 16.3.2 User-defined settings „MODE U“ / setting for KERN –YKB-01N

In the menu item „MODE U“ every communication parameter can be set individually.

#### 1. Invoke Data Output menu

⇒ Press **PRINT** for 3 sec. in weighing mode.



#### 2. Select function

⇒ Press the navigation buttons (↓ ↑) repeatedly until „**COMM.SET**“ is displayed.

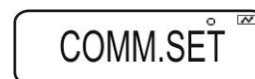

⇒ Confirm with **PRINT**

⇒ Press the navigation buttons (↓ ↑) repeatedly until the desired mode „**MODE 1 - MODE 5**“ is displayed. The current setting is marked by the stability display (→).



with (→) on



without (→) off



⇒ Change using **TARE**.

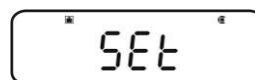

### 3. Set the communication speed (Baud rate)

- ⇒ Press **PRINT**
- ⇒ Press the navigation buttons (↓ ↑) repeatedly until „**START**“ is displayed.
- ⇒ Press **PRINT**. The current setting is marked by the stability display (→).
- ⇒ Press the navigation buttons (↓ ↑) repeatedly until the desired setting (e.g. 9600 bps) appears.
- ⇒ Press **TARE**.

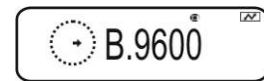
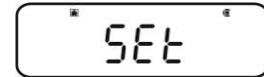
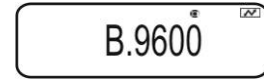

Selectable settings:

Display	B0.300	B0.600	B0.1200	B0.2400	B0.4800	B0.9600	B.19.2k	B.38.4k
Baud rate	300bps	600bps	1200bps	2400bps	4800bps	9600bps	19.2k bps	38.4k bps

### 4. Set parity

- ⇒ Use **ON/OFF** to return to menu
- ⇒ Press the navigation buttons (↓ ↑) repeatedly until „**PARITY**“ is displayed.
- ⇒ Press **PRINT**. The current setting is marked by the stability display (→).
- ⇒ Press the navigation buttons (↓ ↑) repeatedly until the desired setting (e.g. P.NONE) appears.
- ⇒ Press **TARE**.

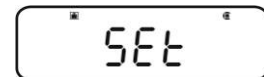
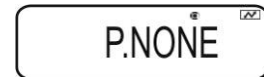

Selectable settings:

Display	P.NONE	P.ODD	P.EVEN
Parity	Small parity, 8 bit	Odd parity, 7 bit	Straight parity, 7 bit

### 5. Stop bit settings

- ⇒ Use **ON/OFF** to return to menu
- ⇒ Press the navigation buttons (↓ ↑) repeatedly until „**STOP**“ is displayed.
- ⇒ Press **PRINT**. The current setting is marked by the stability display (→).
- ⇒ Press the navigation buttons (↓ ↑) repeatedly until the desired setting (e.g. S. 1) appears.
- ⇒ Press **TARE**.

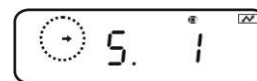
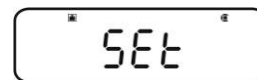
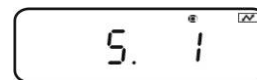

Selectable settings:

Display	S. 1	S. 2
Stop bit	1 bit	2 bit

### 6. Set handshake

- ⇒ Use **ON/OFF** to return to menu
- ⇒ Press the navigation buttons (↓ ↑) repeatedly until „**HAND.SHK**“ is displayed.
- ⇒ Press **PRINT**. The current setting is marked by the stability display (→).
- ⇒ Press the navigation buttons (↓ ↑) repeatedly until the desired setting (e.g. HS.HW) appears.
- ⇒ Press **TARE**.

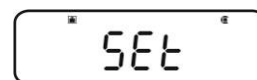

Selectable settings:

Display	HS.OFF	HS.HW	HS.SW	HS.TIM
Handshake	No handshake	Hardware handshake	Software handshake	Timer handshake

## 7. Set data format

- ⇒ Use **ON/OFF** to return to menu
- ⇒ Press the navigation buttons (↓ ↑) repeatedly until „**D.FORM**“ is displayed.
- ⇒ Press **PRINT**. The current setting is marked by the stability display (→).
- ⇒ Press the navigation buttons (↓ ↑) repeatedly until the desired setting (e.g. DF.1) appears.
- ⇒ Press **TARE**.

Selectable settings (details see chpt. 15.4):

Display	DF.1	DF.2	DF.3	DF.4	DF.FREE
Data format	Shimadzu Standard	Shimadzu Standard	Mettler Standard	Sartorius Standard	Options: Head byte 1 -17, Data length 8 -2

## 8. Set separator

- ⇒ Use **ON/OFF** to return to menu
- ⇒ Press the navigation buttons (↓ ↑) repeatedly until „**DELIM**“ is displayed.
- ⇒ Press **PRINT**. The current setting is marked by the stability display (→).
- ⇒ Press the navigation buttons (↓ ↑) repeatedly until the desired setting (e.g. DF.1) appears.
- ⇒ Press **TARE**.

Selectable settings:

Display	CR	LF	CR+LF	COMMA	WINI
Separator	CR	LF	CR+LF	COMMA	not documented

## 9. Return to weighing mode

- ⇒ Press **ON/OFF** repeatedly or for 3 s.

## 16.4 Data Formats

In the menu item „D.FORM“ four data formats „DF.1-DF.4“ are available.

☞ Menu setting, see chpt. 16.3.2, step 7 „Setting data format“.

### 1. Data format 1 „DF.1“

Example 9.9949 g:

Position	data	ASCII code	Explanation	
1		20H	Positive weighing value = space character 20H Negative weighing value = minus sign 2DH	
2		20H	Numeric weighing value is displayed in 8 positions. Not required positions = space character 20H Where necessary, Overload is displayed in 2 positions with O L	
3		20H		
4	9	39H		
5	.	2EH		
6	9	39H		
7	9	39H		
8	4	34H		
9	9	39H		
10	g	67H		Weighing unit
11		20H		
12	C/R	0DH	Separator C/R = 0DH, L/F = 0AH At CR+LF data length will be increased	

Printout examples KERN YKB-01N

9.9949g

Stable or instable/positive weighing value

-9.9949g

Stable or instable/negative weighing value



## 2. Data format 2 „DF.2“

Example 9.9949 g:

Position	Data	ASCII code	Explanation
1		20H	Positive weighing value = space character 20H Negative weighing value = minus sign 2DH Stable weighing value = S (stable) 53H Unstable weighing value = U (unstable) 55H
2		20H	
3	U	55H	
4		20H	
5		20H	
6		20H	
7		20H	Numeric weighing value is displayed in 8 positions. Not required positions = space character 20H Where necessary, Overload is displayed in 2 positions with O L
8		20H	
9	9	39H	
10	.	2EH	
11	9	39H	
12	9	39H	
13	4	34H	
14	9	39H	
15		20H	Weighing unit
16	g	67H	
17	C/R	0DH	Separator C/R = 0DH, L/F = 0AH At CR+LF data length will be increased

### Printout examples KERN YKB-01N

S	9.9949 g
---	----------

Stable/positive weighing value

U	9.9949 g
---	----------

Instable/positive weighing value

S	-9.9949 g
---	-----------

Stable/negative weighing value

U	-9.9949 g
---	-----------

Instable/negative weighing value

### 3. Data format 3 „DF.3“

Example 9.9949 g:

Position	Data	ASCII code	Explanation
1	+	2BH	Positive weighing value = plus sign 2BH Negative weighing value = minus sign 2DH
2		20H	
3		20H	Numeric weighing value is displayed in 8 positions. Not required positions = space character 20H Where necessary, Overload is displayed in 2 positions with O L
4		20H	
5	9	39H	
6	.	2EH	
7	9	39H	
8	9	39H	
9	4	34H	
10	9	39H	
11		20H	
12	g	67H	
13		20H	
14		20H	
15	C/R	0DH	Separator C/R = 0DH, L/F = 0AH At CR+LF data length will be increased

Printout examples KERN YKB-01N

+9.9949 g Stable or instable/positive weighing value

-9.9949 g Stable or instable/negative weighing value

#### 4. Data format 4 „DF.4“

Example 9.9949 g:

Position	Data	ASCII code	Explanation
1	S	53H	Stable weighing value = S (stable) 53H Unstable weighing value = U (unstable) 55H Positive weighing value = plus sign 2BH Negative weighing value = minus sign 2DH
2		20H	
3		20H	
4		2BH	
5		20H	Numeric weighing value is displayed in 8 positions. Not required positions = space character 20H Where necessary, Overload is displayed in 2 positions with O L
6	+	2BH	
7	9	39H	
8	.	2EH	
9	9	39H	
10	9	39H	
11	4	34H	
12	9	39H	
13		20H	Weighing unit
14		20H	
15	g	67H	
16	C/R	0DH	Separator C/R = 0DH, L/F = 0AH At CR+LF data length will be increased

#### Printout examples KERN YKB-01N





S +9.9949 g Stable/positive weighing value

U +9.9949 g Instable/positive weighing value

S -9.9949 g Stable/negative weighing value

U -9.9949 g Instable/negative weighing value

## 16.5 Remote control instructions

Command	Function
D01	Continuous data output
D02	Continuous data output of stable weighing values
D03	Status of stability display is attached to the data in the continuous output. U: instable S: stable
D05	Single output
D06	Automatic output
D07	Single output. Status of stability display is attached to the data in the output. U instable S: stable
D08	Single output with stable weighing value
D09	Cancel output
BREAK	Function as  , see chpt. 3.1
Q	
CAL	Function as  , see chpt. 3.1
TARE	Function as  , see chpt. 3.1
T	
PRINT	Function as  , see chpt. 3.1

## 17 Service, maintenance, disposal

### 17.1 Cleaning



Before cleaning, disconnect the appliance from the operating voltage.

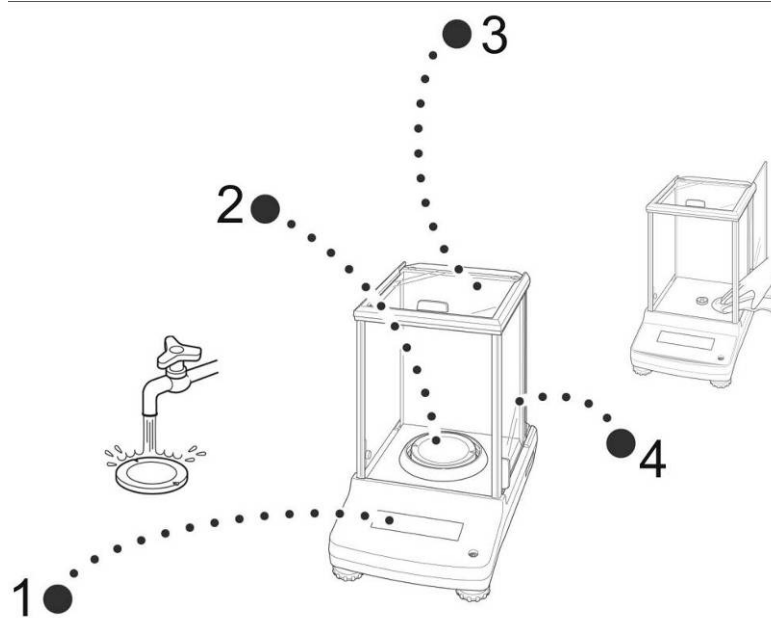

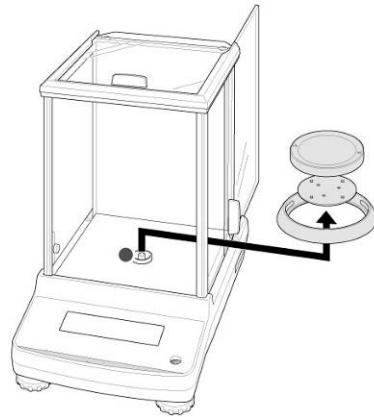

Fig. 1: Clean the balance

- 1. Display** Please do not use aggressive cleaning agents (solvents or similar agents), but a cloth dampened with mild soap suds.
- 2. Weighing plate** Remove weighing plate, clean it wet and dry it before installation
- 3. casing, housing, case, box** Please do not use aggressive cleaning agents (solvents or similar agents), but a cloth dampened with mild soap suds. Take care that the device is not penetrated by fluids and polish it with a dry soft cloth.  
Loose residue sample/powder can be removed carefully with a brush or manual vacuum cleaner.  
**Spilled weighing goods must be removed immediately.**
- 4. Glass doors** These can be removed as described in the following. After that clean with a commercially available glass cleaner.  
 Handle glass doors with care.  
**Attention:** Risk of breakage  
Risk of cuts.  
Keep away your hands/fingers from the running rail.

1. Remove, screening ring, weighing plate and carrier of weighing plate



2. Remove the plastic handle by turning.



Do not touch the support of the weighing plate. This could cause damage to the balance.

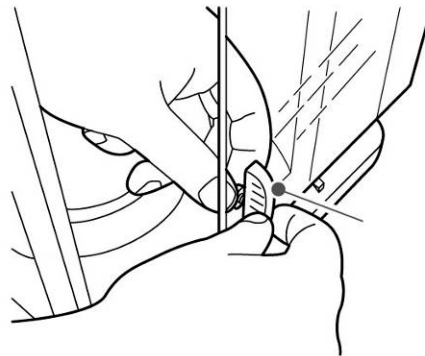

3. Remove glass door carefully acc. to fig.

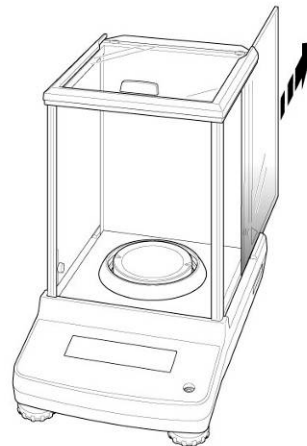

Fig. 2: Remove the glass doors

4. Re-install the glass door in reverse order.



To secure the glass door always reattach the plastic handle.

## 17.2 Service, maintenance

The appliance may only be opened by trained service technicians who are authorized by KERN. Before opening, disconnect from power supply.

## 17.3 Disposal

Disposal of packaging and appliance must be carried out by operator according to valid national or regional law of the location where the appliance is used.

## 18 Instant help

### Possible causes of errors:

In case of an error in the program process, briefly turn off the balance and disconnect from power supply. The weighing process must then be restarted from the beginning.

Fault	Possible cause
The displayed weight does not appear	<ul style="list-style-type: none"><li>• The balance is not switched on.</li><li>• The mains supply connection has been interrupted (mains cable not plugged in/faulty).</li><li>• Power supply interrupted.</li></ul>
The displayed weight is permanently changing	<ul style="list-style-type: none"><li>• Draught/air movement</li><li>• Glass doors not closed</li><li>• Table/floor vibrations</li><li>• Weighing plate has contact with other objects.</li><li>• Electromagnetic fields / static charging (choose different location/switch off interfering device if possible)</li></ul>
The weighing result is obviously incorrect	<ul style="list-style-type: none"><li>• The display of the balance is not at zero</li><li>• Adjustment is no longer correct.</li><li>• The balance is on an uneven surface.</li><li>• Great fluctuations in temperature.</li><li>• Electromagnetic fields / static charging (choose different location/switch off interfering device if possible)</li></ul>
The desired weighing unit cannot be called by <b>UNIT</b> key.	<ul style="list-style-type: none"><li>• Unit was not activated beforehand.</li></ul>
Automatic adjustment carried out frequently.	<ul style="list-style-type: none"><li>• Severe temperature variations in the room or the instrument</li></ul>
No data transfer between printer and balance.	<ul style="list-style-type: none"><li>• Communication settings are wrong.</li></ul>
The menu settings cannot be changed.	<ul style="list-style-type: none"><li>• The menu is locked Remove the menu lock.</li></ul>

## 18.1 Error messages

Error message	Explication	Remedy
<b>ERR H</b>	Hardware error	Switch balance off and on again. If the error message remains inform manufacturer.
<b>ERR C</b>	High zero point shift during adjustment	Use <b>ON/OFF</b> to return into weighing mode. Restart adjustment process.
	Objects present on weighing plate.	
	Missing weighing plate	
<b>CAL D</b>	Display instable	Check ambient conditions (draught, vibrations etc.) Use <b>ON/OFF</b> to return into weighing mode. Restart adjustment process.
<b>ERR N</b>	Error at numerical input (e. g. wrong password)	Correct input
<b>ERR W</b>	Wrong application	The balance changes to the previous state. Correct application.
<b>COM ERR</b>	Wrong remote control order.	The balance changes to the previous state. Correct remote control order.
<b>- OL</b>	Missing weighing plate	Install weighing plate correctly
<b>OL</b>	Overload	Reduce load
<b>ABORT</b>	Process cancelled	
<b>WAIT</b>	Wait for process	
<b>BUSY</b>	When adjustment was started objects were present on weighing plate	Remove object and continue adjustment

Should other error messages occur, switch balance off and then on again. If the error message remains inform manufacturer.