

# **Axiovert 200**

## **The New Standard in Inverted Microscopy**

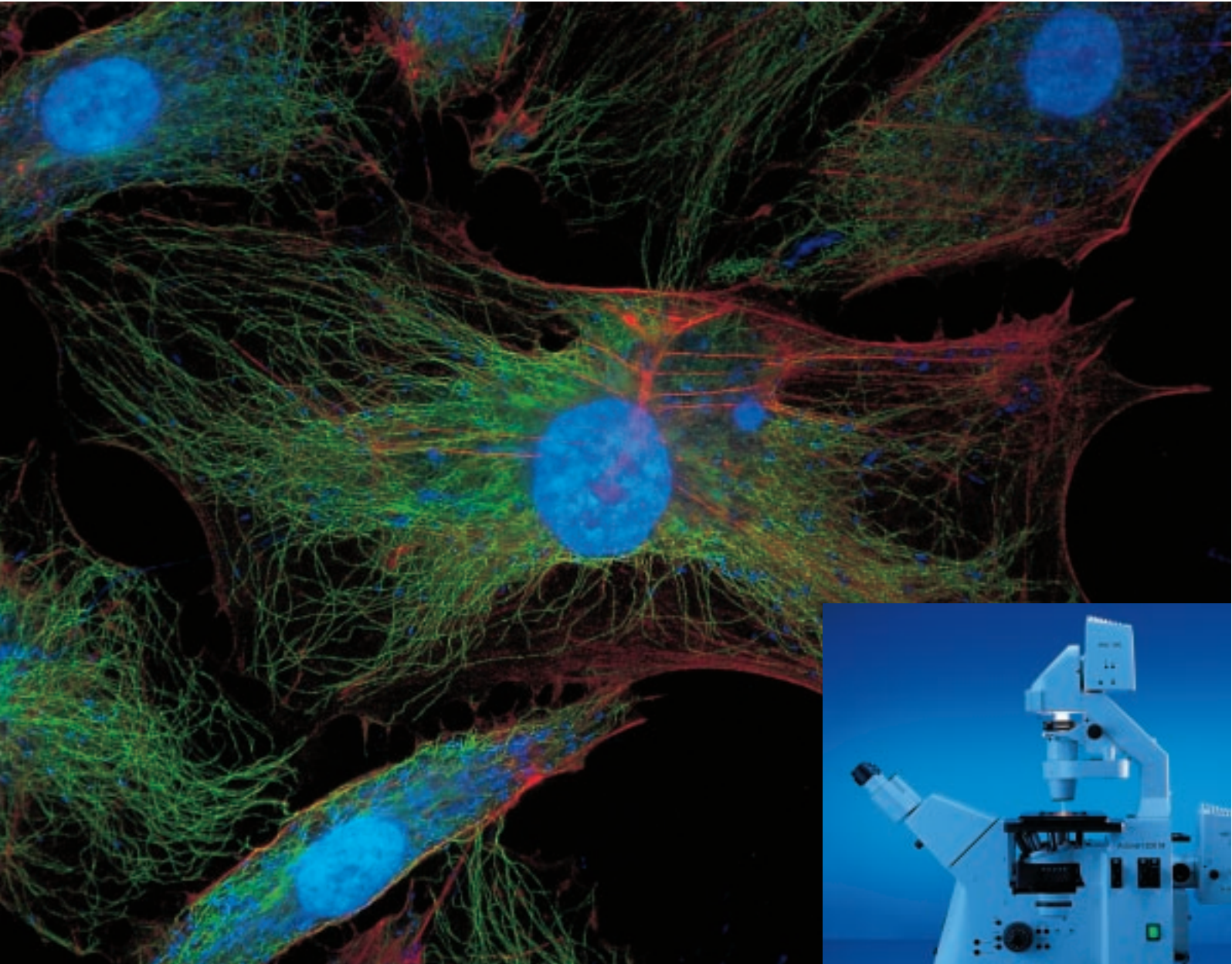

**If you need the best,  
there is simply no alternative**



# Axiovert 200

## Unique Down to the Last Detail

Live cell imaging, micromanipulation on living cells – never before have such rigorous demands been placed on the stability, flexibility, reliability and operating comfort of microscopes. And never before has there been a microscope capable of meeting these demands with such ease and elegance. Its name: **Axiovert 200**, the state of the art in inverted microscopy from Zeiss.

**Axiovert 200** is based on the extraordinary expertise and experience of a company which has been setting international standards in inverted microscopy since 1924. A company that developed the first microscope with infinity optics. But above all: this high-end microscope surpasses earlier models in every crucial detail: the outstanding Zeiss optics with the wide range of ICS objectives, with innovative condensers and optimized fluorescence as well as with an unusual scope of sophisticated documentation and adaptation options, exceptional stability and unique ergonomic design.

And **Axiovert 200 M** gives you the freedom to automate many routine procedures – so you save time with no loss in reliability.

As a matter of fact, **Axiovert 200** is much more than the sum of its benefits. And why? Because it gives you a powerful basis to carry out your work in all life science applications more precisely, more rapidly and more successfully than before. In other words: it gives you the basis that ensures you're in the lead. And that's exactly where you need to be in science today.

## Milestones

100 years of tradition and innovation in inverted microscopy – with developments that set the standards of their time. Now a new microscope from Carl Zeiss is continuing this success story: **Axiovert 200**, yet another milestone in research and routine.

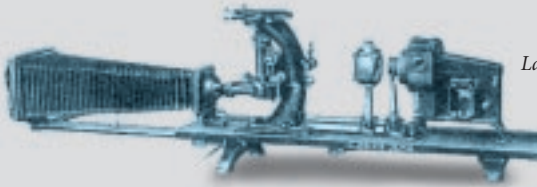

*Large Metal Microscope*

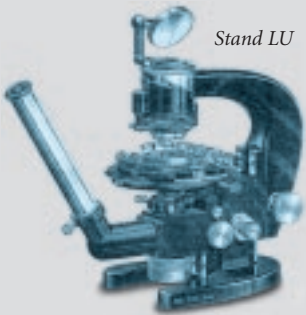

*Stand LU*

**1924** Large research microscope with the first “infinite” objectives in the world.

**1934** Neophot – the microscope with the first darkfield and Köhler illumination.

**1935** Lu stand – the first upright basic stand that could be converted into an inverted one.



*Axiomat IDC*

**1968** Telaval – movable stage, upright non-mirror image, microphotography with automatic exposure.

**1973** Axiomat IDC – the start of inverted high-performance microscopy with its own infinite optics.

**1973** Invertoskop D – for routine applications.



*IM 35*

**1976** IM and IM 35 – the first inverted microscopes for all contrasting methods, including reflected light fluorescence.

**1987** The first Axiovert generation – worldwide the first with complete ICS optics (Infinity Color Corrected Optical System).

**2000** Axiovert 200 – the beginning of a new era in inverted high-end microscopy.

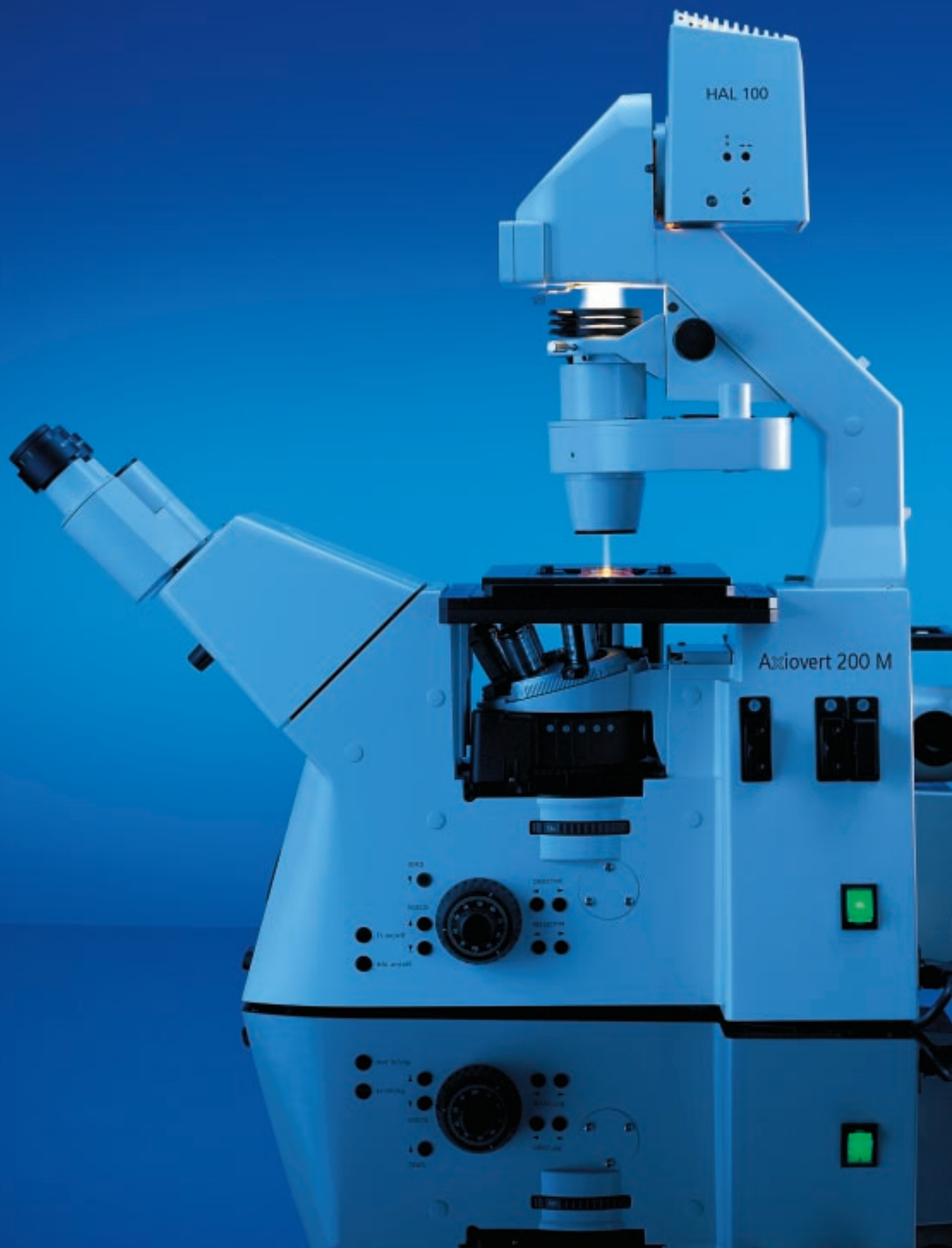



# Axiovert 200 - The Optics Limited Only by the Laws of Physics

$$d = \frac{\lambda}{2n \sin \alpha}$$

Ever since Ernst Abbe and his famous formula, it is a known fact that resolution is determined by the numerical aperture of the objective and the condenser. Only when the quality and interaction of both components are 100 % perfect – as with **Axiovert 200** – is image quality optimal. ICS infinity optics: limited only by the laws of physics.

## The Objectives: Excellent in Contrast

LD – long distance – objectives and LD condensers: The extra long working distance is especially important in inverted microscopy in order to penetrate thick vessels as easily as possible.

The LD A-Plan objectives have already been corrected for all standard 1 mm chamber thickness (+/- 0.4 mm), thereby yielding results that are strong in contrast and free of aberrations.

*Optics to perfection.  
For every method, Zeiss  
provides you with a wide  
range of ICS objectives*



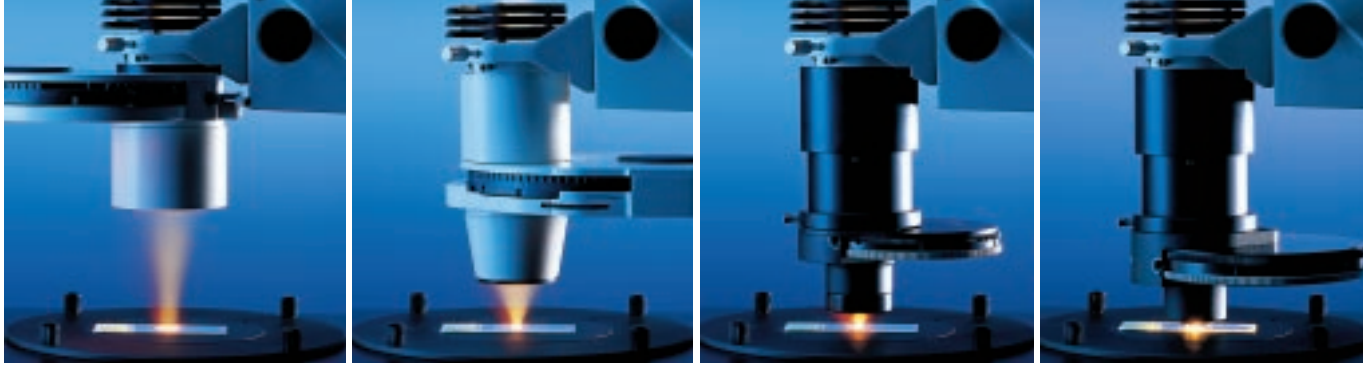

**The New Condensers:  
Distinguished  
by Distance**

More space for manipulation in microscopy: With N.A. 0.35 (WD 70 mm) and N.A. 0.55 (WD 26 mm), the new top LD condensers offer considerably more working distance – so important for easy handling of manipulators and rapid observation of the sample. But also more freedom in contrasting methods. The new LD condensers can be used in every area of application, thanks to their numerous modulators for Phase contrast, Varel or DIC. A new and highly interesting feature: DIC prisms can even be used with the condensers with an N.A. of 0.35. Convincing evidence of **Axiovert 200's** impressive flexibility: A special adapter allows you to use the high-resolution condensers with N.A. of 0.8 and 1.4 from the family of upright microscopes.

**The Observation Tubes:  
Flexibility  
in Focusing**

**Axiovert 200** meets all demands with three tubes:

1. Binocular tube. The integrated shutter prevents ambient light from entering the stand through the eyepiece during low light level image acquisition, thereby contributing stray light.
2. Phototube. Features TV port (60 mm interface) with 3 positions (vis/photo: 0/100, 100/0 and 50/50), shutters and additional focusing Bertrand lens for easy adjustment of the phase rings.
3. Height adjustable Ergotube with focusing Bertrand lens, shutter and an ergonomically ideal 25° viewing angle, with 50 mm range of travel. Now fatigue-free work for hours on end is no longer a problem.



(From top to bottom)  
Binocular tube  
Phototube  
Ergotube

*The new LD condensers. Making sure that ICS optics provide full performance potential.*

- N.A.: 0.35 – WD 70 mm, for BF; Ph 0, 1, 2; DIC I, II; Var 1
- N.A.: 0.55 – WD 26 mm, for BF; Ph 1, 2, 3; DIC I, II, III; Var 1, 2
- N.A.: 0.8 – WD 7 mm, for BF; Ph 1, 2, 3; DIC III; D 0,6, 0,8
- N.A.: 1.4 – oil immersion, for BF; Ph 2, 3; DIC II, III; D 1,1, 1,2

# Axiovert 200 - The Contrasting Methods

Quality and versatility:

**Axiovert 200** is ready for every contrasting method. And consequently for the solution that works the best for your application and makes the most economic sense.

## **Double the Benefit: Two Methods - One Objective**

A quick look at the range of Zeiss objectives is enough to convince you of the benefits they offer. The Varel objectives are a combination of phase contrast and Varel, thereby providing you with the unique possibility of imaging your specimens both three-dimensionally and in phase contrast. Depending on the application, you decide which method you would like – without changing the objective. The Zeiss **Variable Relief** contrast is so versatile that it can be used for all cells, no matter what type, no matter how thick. Additional flexibility that will considerably simplify your work.

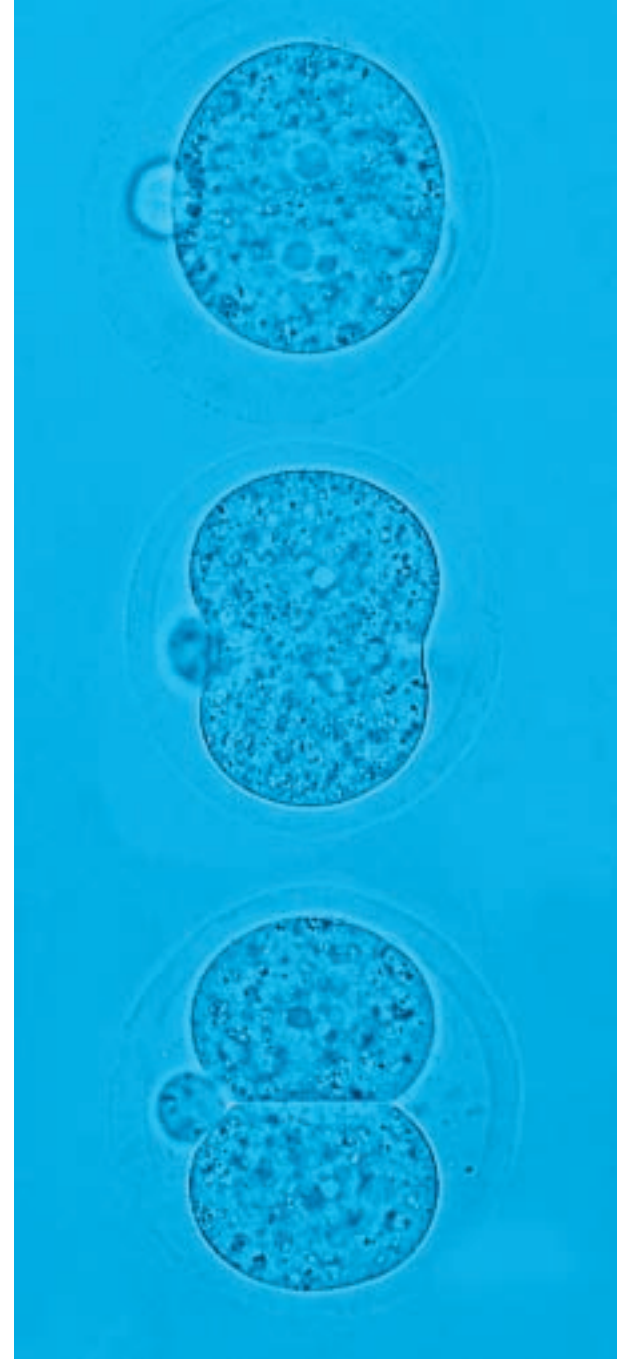

*Electrofusion of 2-cell stage embryo, phase contrast, K. Vintersten, S. Gray, EMBL Heidelberg*

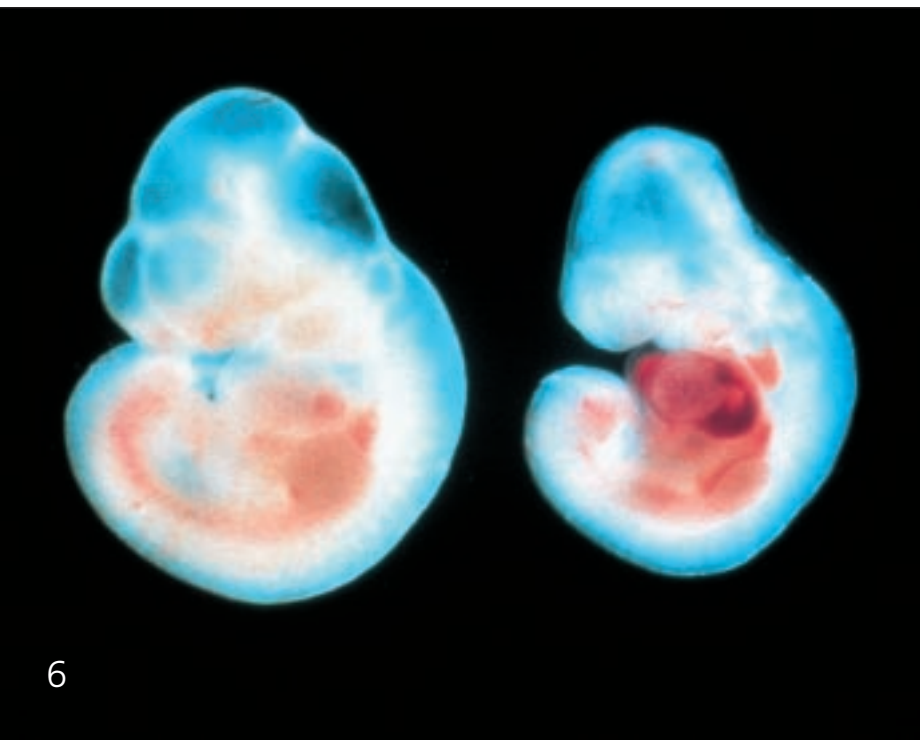

*Normal embryo and mutant, darkfield, R. Adams, EMBL Heidelberg*



# A Powerful Program

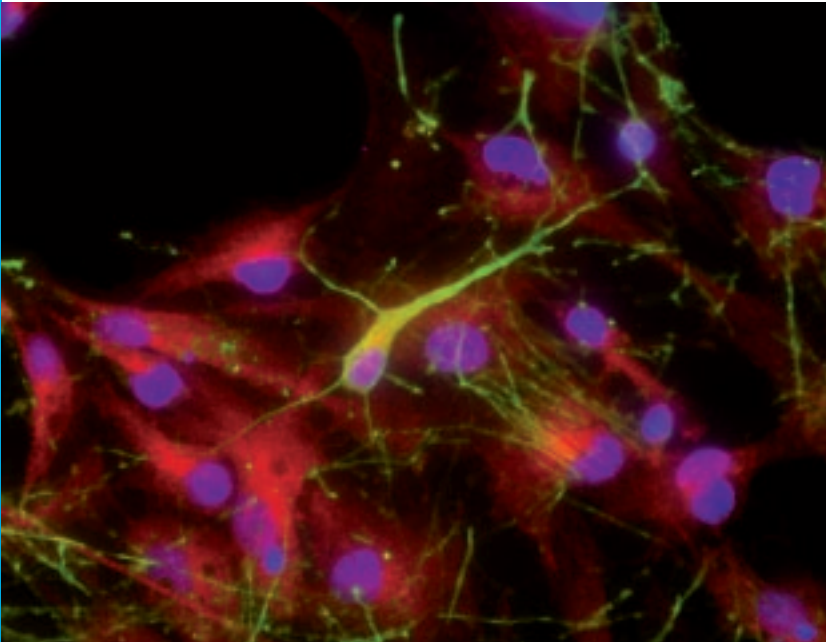

*Embryonic rat cells,  
triple fluorescent labeling,  
R. Learish, Promega  
Corporation, Madison,  
WI*

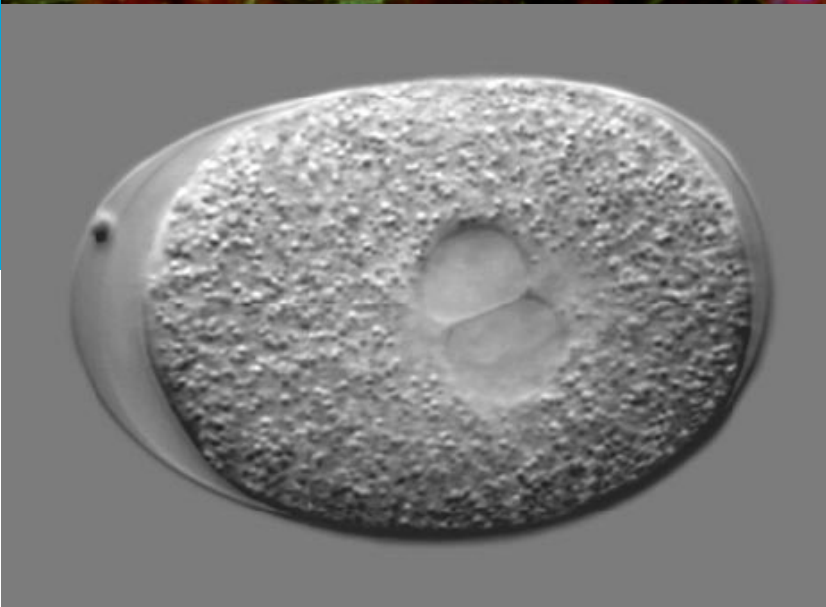

*C. elegans, embryo, DIC,  
Prof. Schnabel,  
Techn. Universität,  
Braunschweig*

## **With or Without Sénarmont: The DIC Methods**

For the best Differential Interference Contrast (DIC) that you have ever seen, you must have the best components. Consequently for every objective there is a DIC slider, positioned in the objective turret, which matches it optimally. There is also the corresponding prism, which is found in the condenser turret. You have the choice of two methods. First: DIC according to Nomarski. Here polarizer and analyzer are at right angles to each other and contrast is achieved by adjusting the DIC slider. Second: DIC with Sénarmont. Instead of a DIC slider, a revolving analyzer with  $\lambda/4$  plate is used to attain contrast. The advantage of the second method – considerably increased accessibility – is particularly evident in the case of larger, lateral setups with cameras and manipulators. Moreover, once the small DIC sliders have been centered, they no longer have to be adjusted.

*Sénarmont analyzer  
and DIC slider*

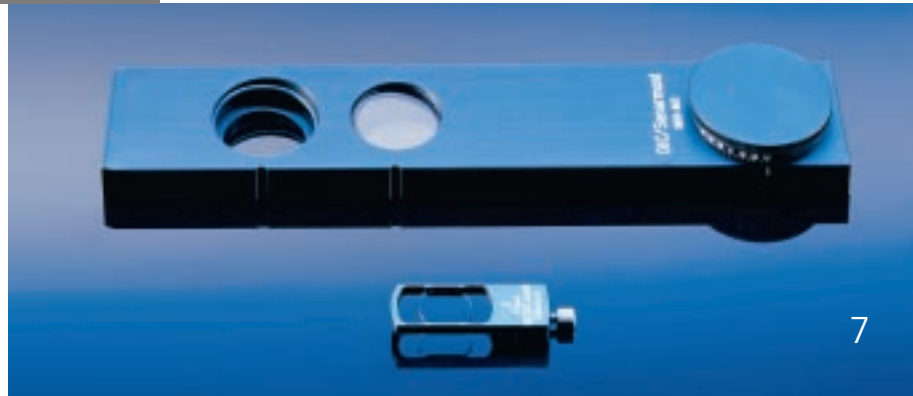

# Axiovert 200 - The New Fluorescence

**Axiovert 200** offers yet more performance, intensity and homogeneity when it comes to fluorescence. It offers innovative ideas and intelligent details which, taken together, provide even higher quality imaging as well as easier and faster handling.

*The new 5x reflector turret with  
Push&Click filter sets*

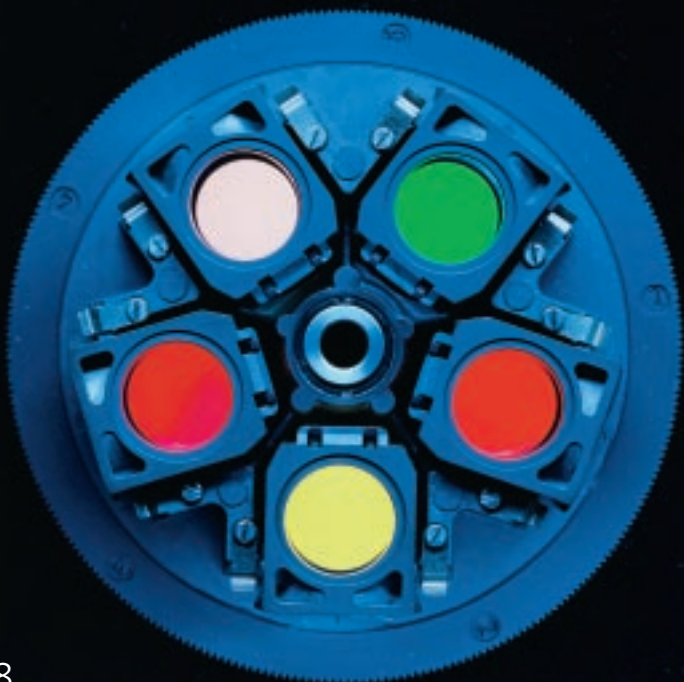

*Human endothelial cells,  
4fold fluorescent  
labeling,  
J. Zbären,  
Inselspital Bern,  
Switzerland*

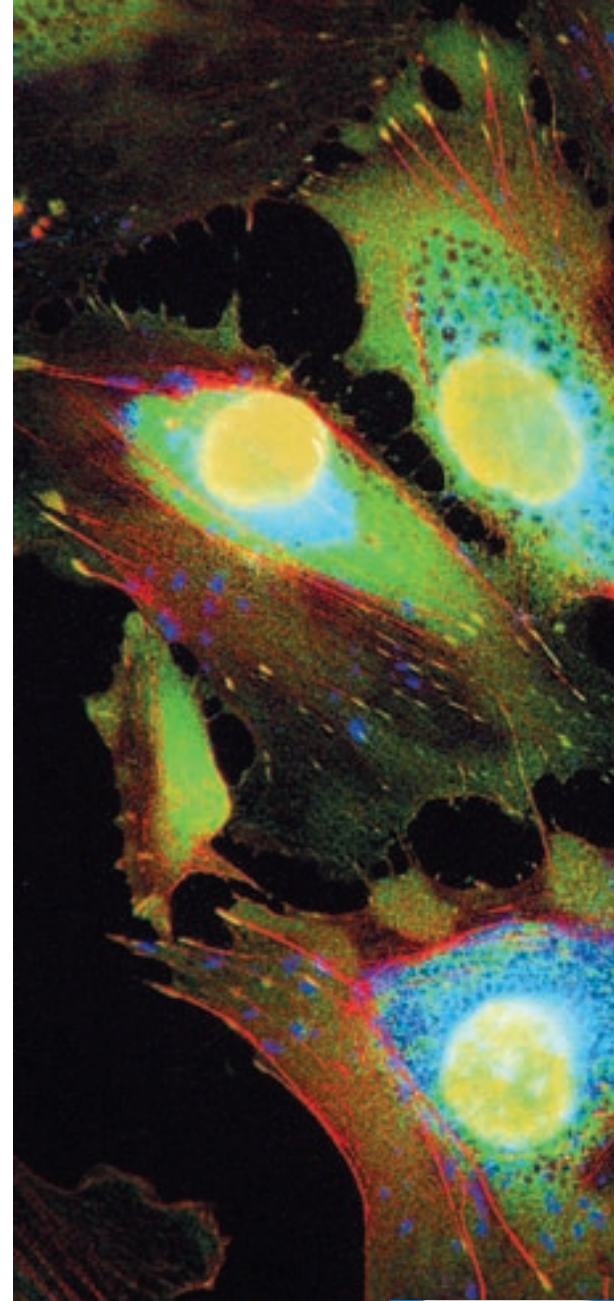

*Easily adjustable:  
HBO illuminator with  
lateral adjusting aid*



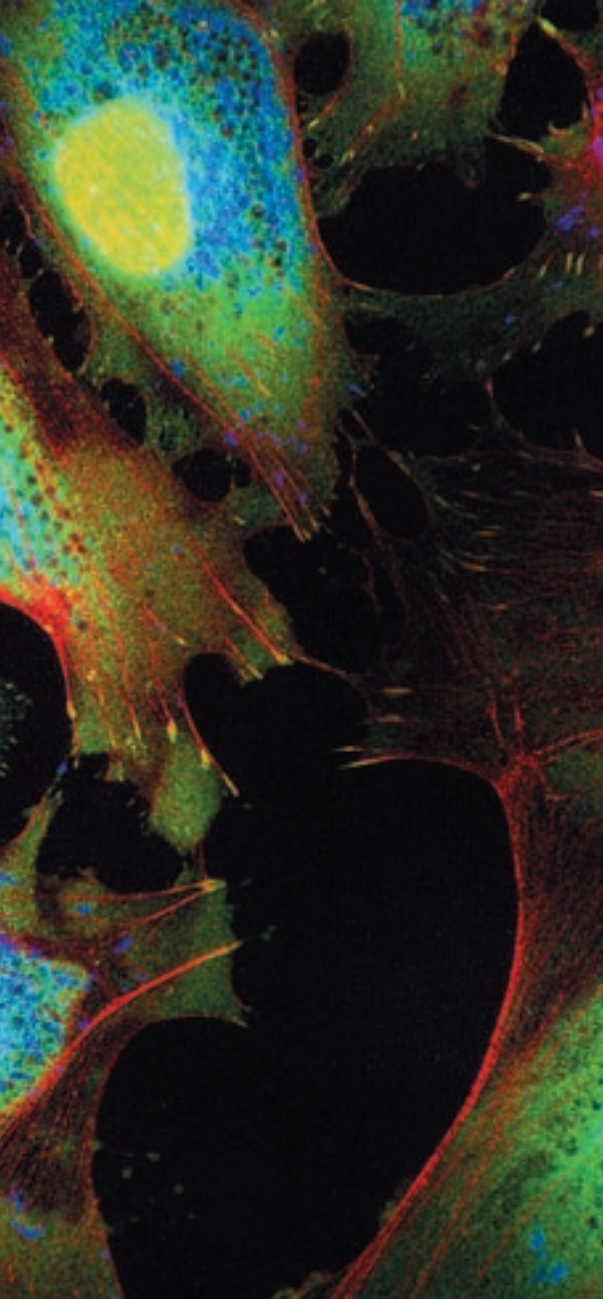

# Innovations Well Worth Looking at

## Signaling Quality: The Light Trap

Much more contrast with much less stray light.

In other words: the best signal-to-noise ratio you'll ever find. The patented Zeiss Light Trap makes this possible by minimizing interfering stray light – and in the process providing **Axiovert 200** with unprecedented brilliance in fluorescence images.

## Just Push&Click: Fluorescence to the Power of Five

Five filter sets with full 23 mm field of view – the **Axiovert 200** reflector turret offers you more flexibility and easier handling. The filter sets can be switched within seconds – just push&click.

And if you want even more: A motorized 8x excitation filter is available for **Axiovert 200 M**.

## Soft Click: Giving Smoothness a New Twist

With Axiovert, rotating the reflector turret by one or more positions is so exceptionally smooth that it has earned a name of its own: **Axiovert 200 Soft Click**. As a result, you have vibration-free micromanipulation and no capillary breakage.

## Greater Versatility: The New HBO Illuminator with AttoArc 2

With the new AttoArc 2 you have continuous brightness control of the HBO illuminator – directly from your PC via microscope software. And there is yet another practical innovation: The burner can be quickly and simply aligned with the adjusting aid and lateral adjusting screws of the new HBO illuminator.

(top)  
Light trap:  
less stray light,  
more contrast

(bottom)  
AttoArc 2  
regulates intensity of  
HBO illuminator

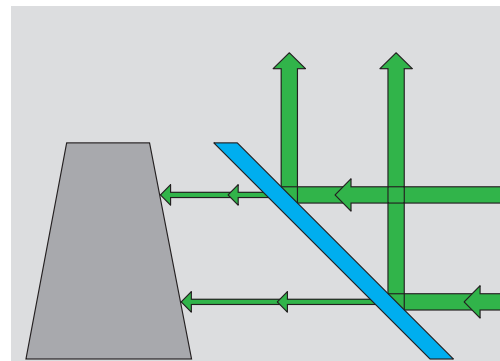

# Axiovert 200 - The New Fluorescence

The superb fluorescence of **Axiovert 200** provides you with sharp contrast and unprecedented image quality. It also provides you with numerous practical features that you will quickly appreciate in your daily work.

*Duodenum (rat),  
J. Zbären,  
Inselspital Bern*

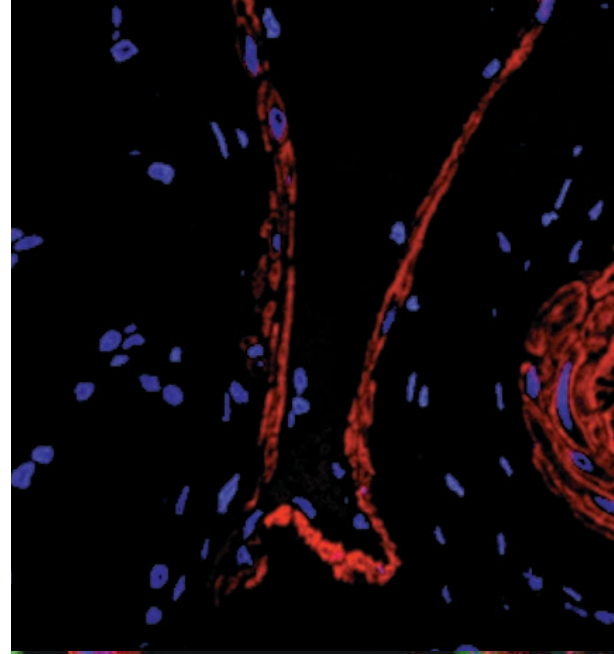

*The epi-fluorescence  
beam path is optimized  
for highest transmission  
over a wide spectral range  
– from UV to IR*

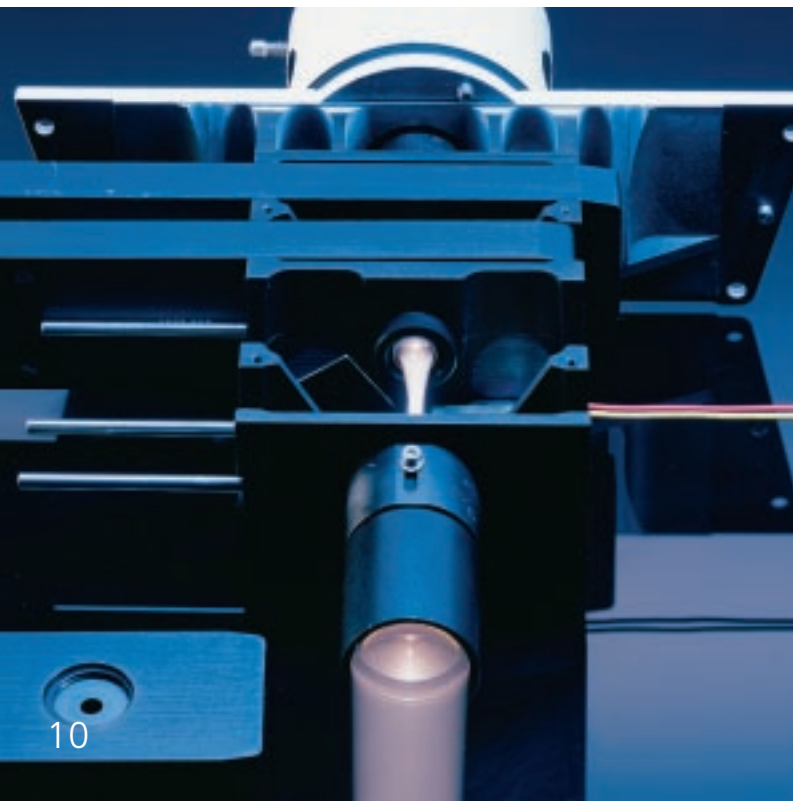
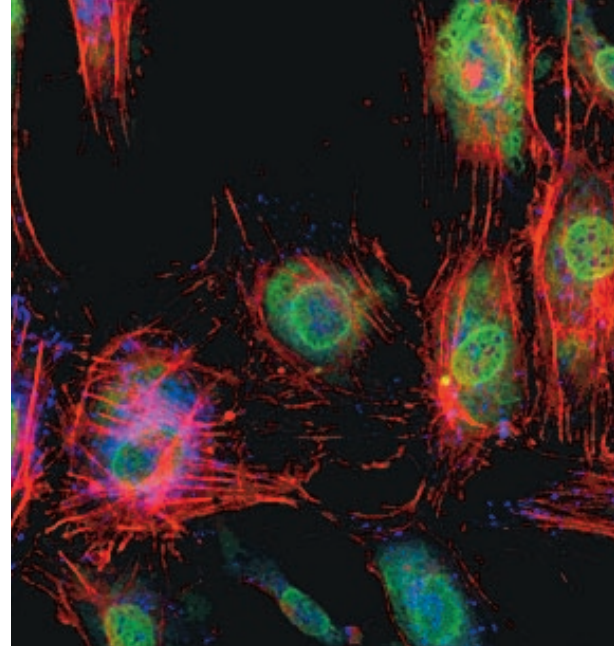

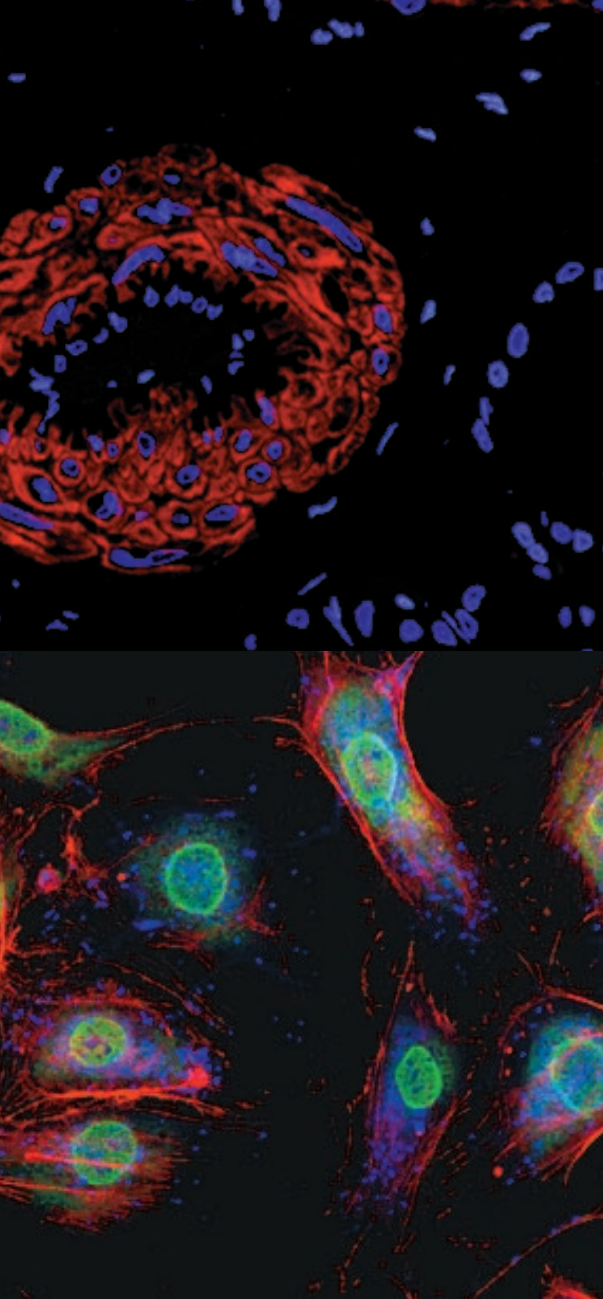

*Endothelial cells,  
J. Zbären,  
Inselspital, Bern,  
Switzerland*

◁ *Aperture and luminous field diaphragm slider, filter slider*

◁ *Ergonomic operation of electric shutter*

# Highlights in Easy Handling

## **Flexibility Means Freedom: The Reflector Turret**

**Axiovert 200 M** allows you to change filter sets at the press of a button or by rotating them manually. It just depends on whether you decide in favor of a manual or motorized reflector turret. And should five reflector modules not be enough, you can easily switch the manual reflector turret – either from the right or from the left, whatever works best for your experiment. A flexibility that is synonymous with freedom, especially in the case of large setups with micromanipulators. Proof yet again of the meticulous attention that **Axiovert 200** pays to those vital details.

## **Practical and Pragmatic: The Sliders and Diaphragms**

Optimal and proper Köhler illumination, even in fluorescence. This is achieved through centerable aperture and luminous field diaphragms, which are available as sliders and can easily be attached to the stand from the side. A further advantage: the accessibility of these diaphragm planes. Ideal when you want to use slit diaphragms or pinhole diaphragms in special applications.

## **Speed with Safety: The Shutter**

The standard electrical shutter in the FL beampath guarantees that fluorescent dyes and samples will never fade. At the press of a button on the front of the stand, the shutter opens and closes the beampath quickly and safely.

## **Well Managed: The Light Manager**

Press a button and the halogen illuminator is easily switched on or off. With a special soft-start function to protect the lamp – and your eyes! Through simple storing, the Light Manager makes it possible to use transmitted light and incident light either separately or simultaneously. Even the manual version of **Axiovert 200** offers this useful feature. The Light Manager in **Axiovert 200 M** offers you much more: for example, storing of the illuminator intensity depending on the Optovar used. Or it offers you contrasting methods with a motorized condenser – depending on the objective used.

# Axiovert 200 - The Interfaces Ready for Your Goals

Almost unlimited possibilities – both for documentation and for manipulation. For the documentation of your work alone, **Axiovert 200** provides you with six camera interfaces – including dual video adapter. All controls are conveniently arranged close to the front of the stand. This means: Switching between single ports and varying ratios is easy. And you decide which step is the right one for your application.

*The Dual Video Adapter:  
For simultaneous documentation  
with two cameras*

## **Diverse: The Optical Interfaces**

**Sideport left:** With two or even three positions for varying ratios.

**Sideport right:** With three positions for varying ratios. The same applies to the additional sideport left.

**Frontport.** The frontport offers you two adapters to connect a digital and a video camera or an SLR camera.

**Baseport.** The ideal interface for extensive experimental setups, especially for the simultaneous use of cameras and manipulators. And ideal, if transmission should be as high as possible.

**Dual Video Adapter.** The adapter for simultaneous imaging with two cameras. Integrated Push&Click filter sets for individual beam splitting. Precisely: one TV port is adjustable in x, y and z direction.

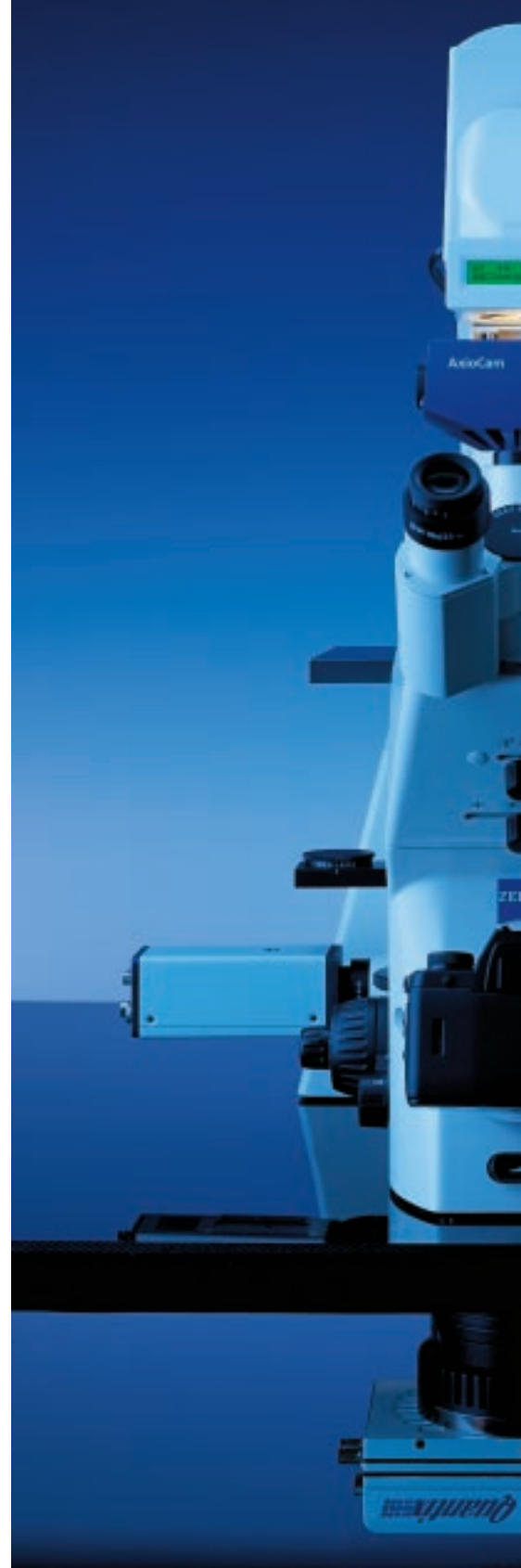

*2-cell mouse embryo,  
DIC, D.L. Keefe,  
MBL, Woods Hole,  
USA*



*Injection in Blastocytes, DIC, K. Vintersten, S. Gray, EMBL Heidelberg, Germany*

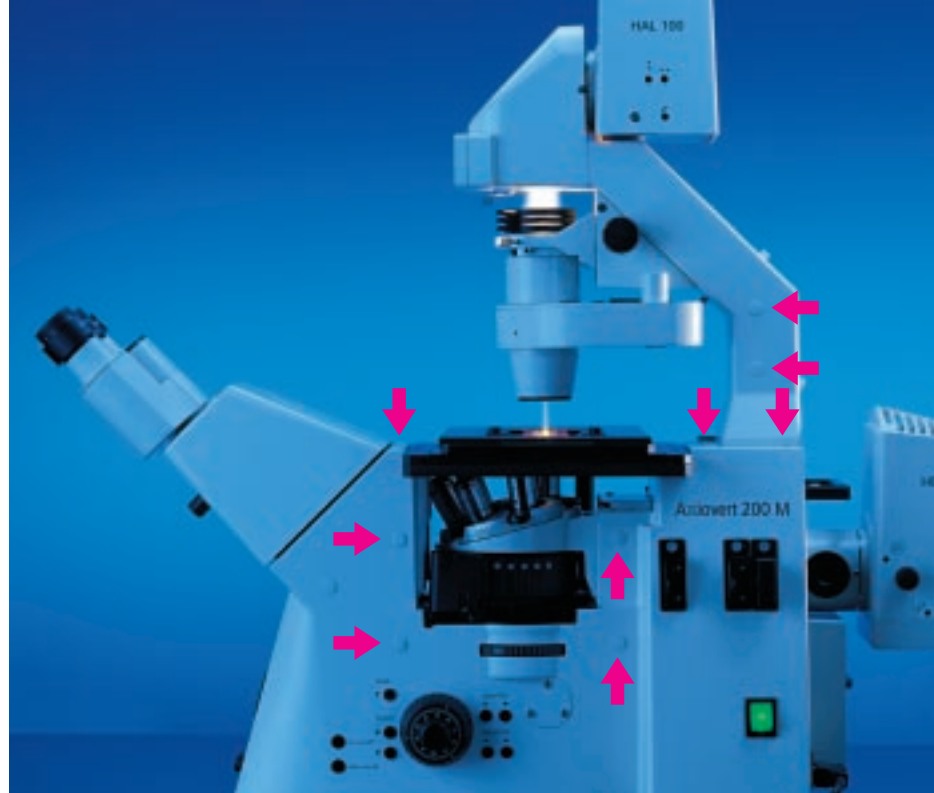

*Possibilities for mechanical adaptation*

**Everything is Possible:  
Interfaces for the Manipulators**

With its many mechanical interfaces, **Axiovert 200** provides you with a wide range of adaptation possibilities – regardless of what manipulator you are using.

Whether on the sides, on the illumination carrier or near the surface of the table, whether conventional manipulation with capillaries and pipettes or with lasers of varying wavelengths – **Axiovert 200** is ready to help you reach your goals.

*Control elements for TV ports:*

- manual stand* ▷
- motorized stand* ▷

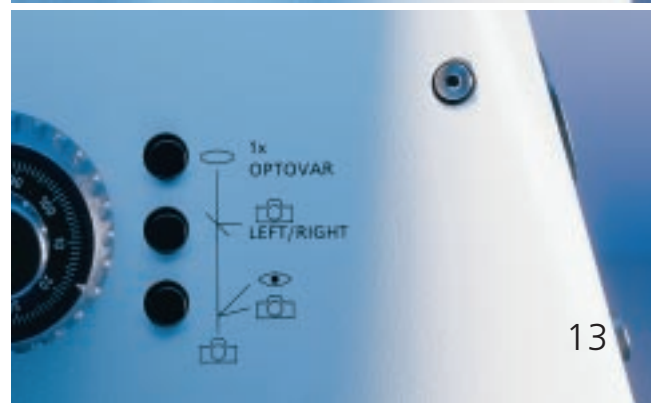

# The Ergonomics Benefits Within Your Grasp

The success of your work depends on easy and fatigue-free operation of a microscope. And through its new ergonomics, **Axiovert 200** helps ensure your success. With benefits that are literally within your grasp: the convenient, easy-to-use arrangement of the controls and the smooth and rapid switching functions. And, of course, with careful attention paid to important details.

All in all, **Axiovert 200** offers you a wealth of sophisticated ergonomic benefits you will appreciate after a long day's work.

## Everything Easily Under Control: The Electric Components

All controls directly near the focusing drive – whether the toggle for lamp intensity, electric shutter for fluorescence light path, buttons for the halogen lamp (on/off), tube lens or sideport turret and baseport slider. So that you have everything easily under control.

## Help in Sight: The Optical Components

Now true help with your work is finally in sight: The analyzer slider with Sénarmont, easily accessible and operable from both sides, guarantees rapid contrast adjustment. The Light Manager, which stores lamp intensities, makes it even easier for you to carry out your work.

## From Ergotube to Object Guide: The Mechanical Components

Individually adjusted to every height – the Ergotube is continuously adjustable. Maintaining all the while a convenient 25° viewing angle. There are other impressive examples of how **Axiovert 200** meets individual needs. It doesn't matter, for example, if you are right-handed or left-handed: The object guide can be located either on the right or the left of the stage. And the focus stop guarantees that the objective turret automatically stops before the objective touches the sample.

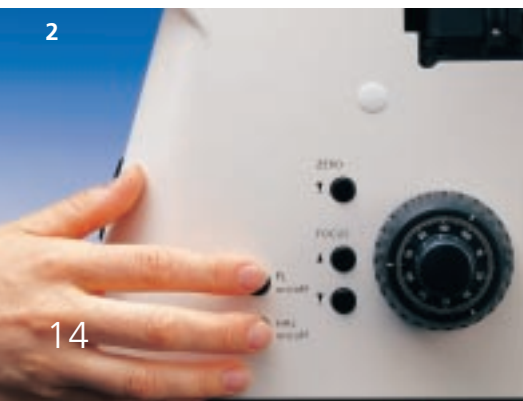
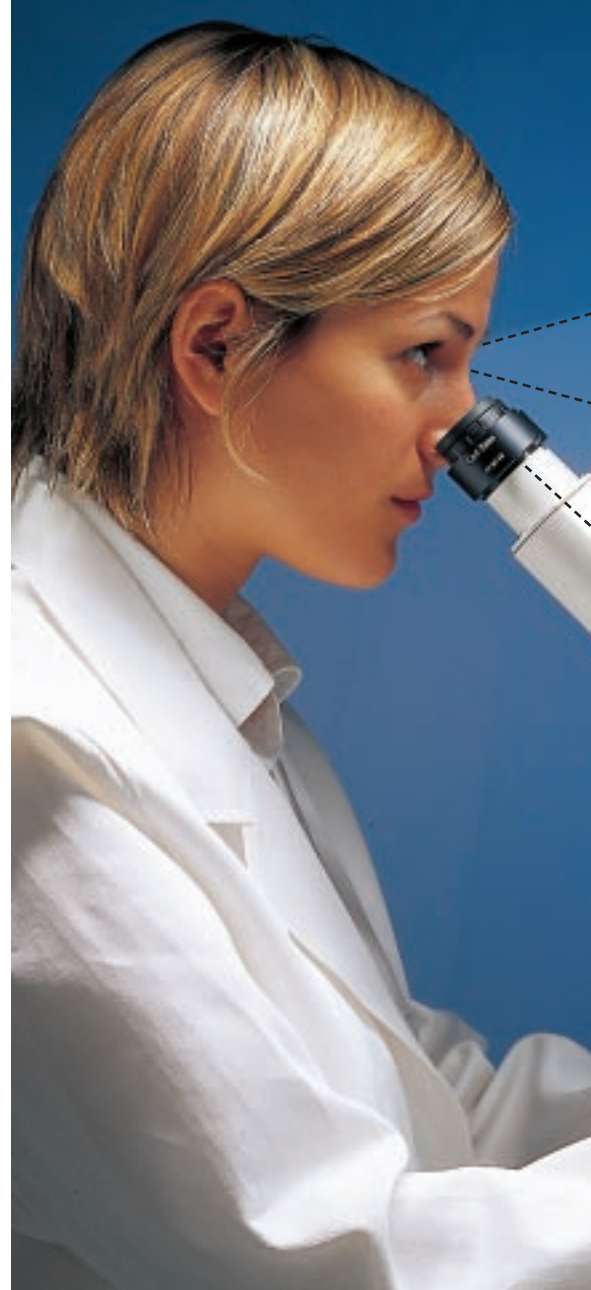



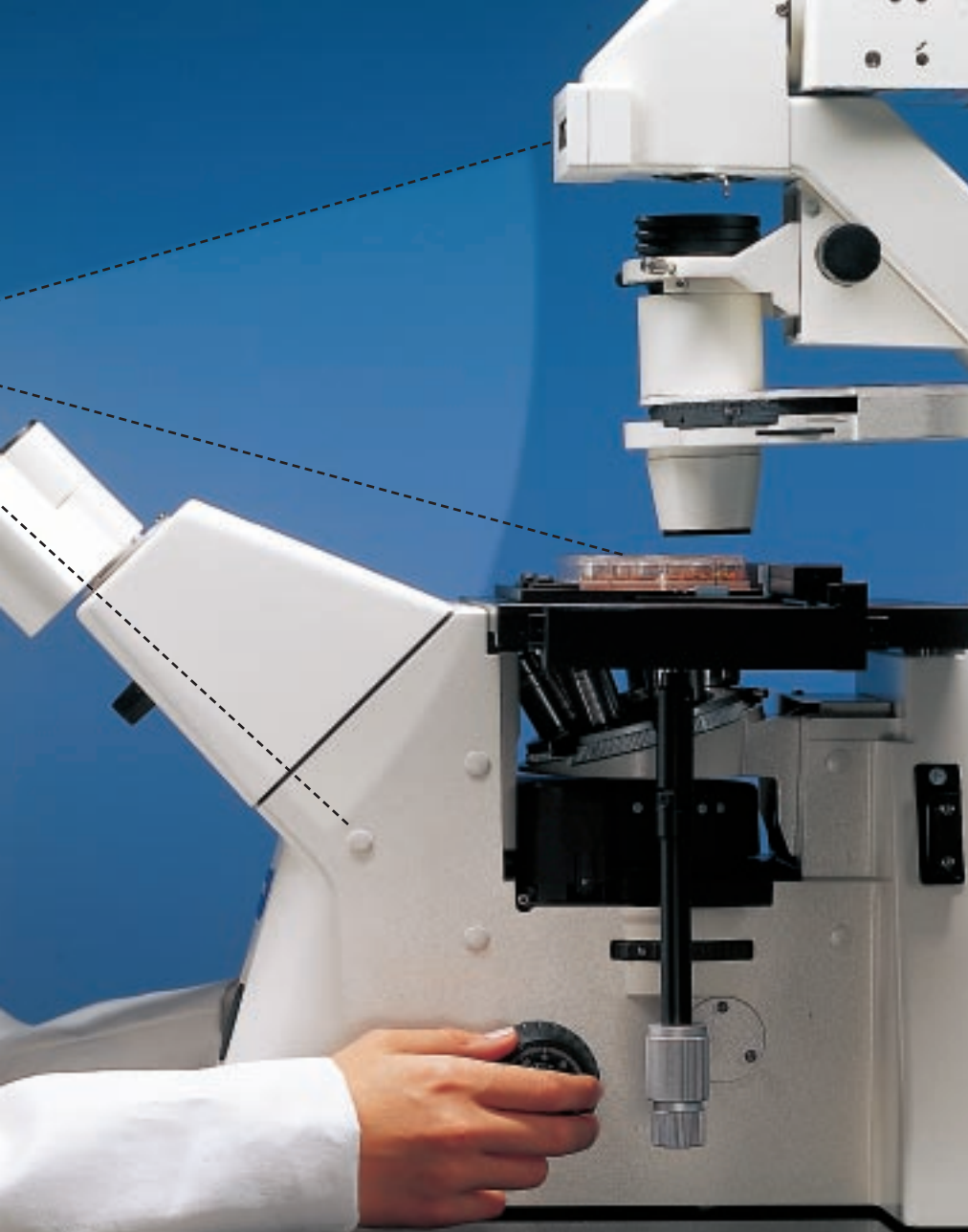

**Powerful Protection:  
Aqua Stop**

The idea is simple, the performance powerful: Aqua Stop, the latest Zeiss innovation. It protects objectives and stands from any liquids that have been spilled. Through a triple protection system. First, through the silicon sealing directly on the objective. Second, through a silicon coating that covers the entire objective turret. And third, through a container placed under the objective turret. Two tubes leading to it channel the liquid away from the microscope. And best of all: Even with Aqua Stop the objective turret remains completely rotary.

**Everything at a Glance:  
The LCD Display**

Just one quick look is enough: the LCD display shows you the current status of the microscope adjustments – whether it's magnification, lamp intensity, shutter position or the z measuring function to determine specimen thickness. At a glance everything you need to carry out your work rapidly and precisely.



- 1) height adjustable Ergotube
- 2) Just push a button – Switching between fluorescence and brightfield
- 3) One touch – focussing and turning the reflector turret
- 4) One turn – easy adjusting of DIC contrast with the Sénarmont analyzer



# Axiovert 200 M

## Motorized Top Performance

In its manual version **Axiovert 200** already makes your work a lot easier. But if you want to exploit its full potential, then you need **Axiovert 200 M**, the fully motorized version. Due to its modular construction it is upgradable at any time according to your needs and budget with a motorized condenser or a motorized reflector turret. All the motorized functions are controlled either by buttons on the stand itself – or via the RS232 interface with PC and corresponding software, for example, AxioVisionControl.



*AxioVisionControl:  
Perfect software control  
from Carl Zeiss*

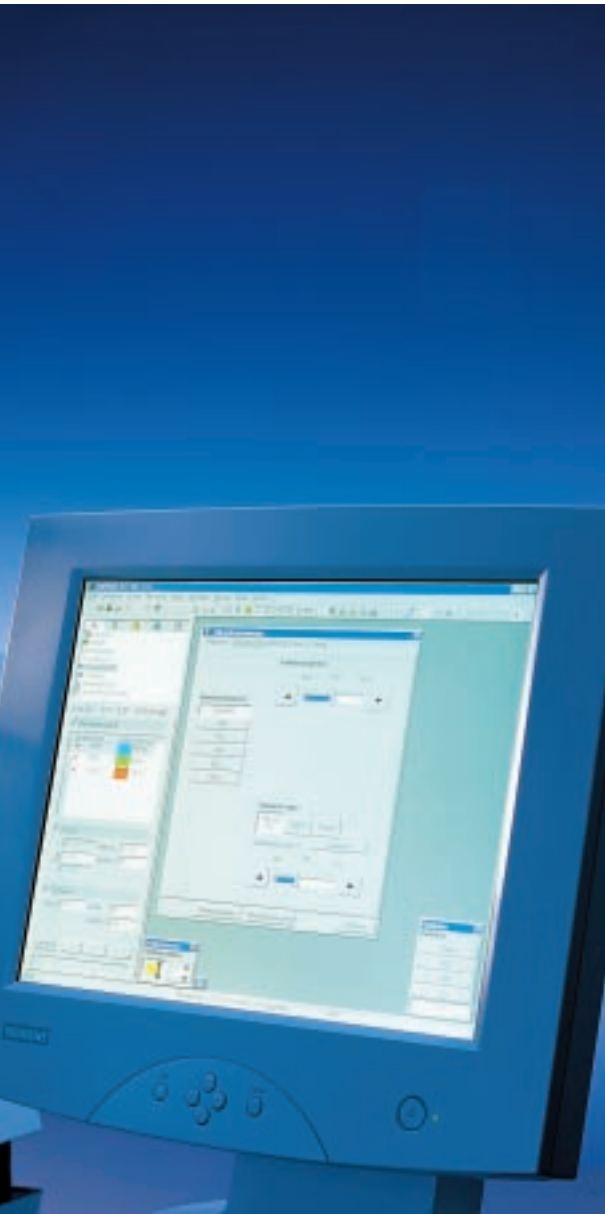

**The Best in Live Cell Imaging:  
Motorization times 8**

Simplifies and speeds up complex operations: With up to eight coded and fully motorized components, **Axiovert 200 M** provides the best conditions for the automation of live cell imaging applications:

- Automatic adjustment of objective and reflector turret
- Automatic setting of previously selected diaphragms and brightness levels via Light Manager
- Choice of five documentation ports via the Electronic Port System (EPS)
- Secondary 1.6x and 2.5x magnification through motorized Optovar system
- Pushbutton controlled fluorescence and halogen lamp shutters
- Z focus with the high-precision Harmonic Drive DC motor for scanning Z specimens with minimum step size of 25 nm, ideal for deconvolution, 6-D imaging and confocal microscopy with LSM 510 and LSM 5 Pascal



*Axiovert 200 M from the back:  
Interfaces for external components*



# The Stages

## The Basis for Your Research

The right stage for every application, the right mounting frame for every specimen – Carl Zeiss has a broad spectrum of accessories precisely matched to the microscope and satisfying your most critical requirements.

### **The Specimen Stage**

With attachable object guide (right- or left-hand) the ideal solution for many applications.

### **The Mechanical Stage**

Latest version of a successful concept: with plane surface, plus the extra-long travels and utmost precision required for multi-well plates.

### **The Gliding Stage**

The top plate with your specimen can be sensitively shifted in any direction as well as rotated. The optimum solution for specimen positioning prior to micromanipulation and for chromosome microdissection.

### **The Motorized Scanning Stage**

PC- or joystick-controlled, this stage allows highly precise positioning of specimen details. Software modules such as Mark&Find in AxioVision handle the saving and retrieving of positions.

With any stage you can select from a wide variety of mounting frames for specimen slides, Petri dishes and vessels of various shapes. **Universal mounting frames** are specially recommended for their versatility. For outstanding precision, choose:

- M for the plain stage,
- K for the mechanical stage,
- MX or KX for multi-well plates.

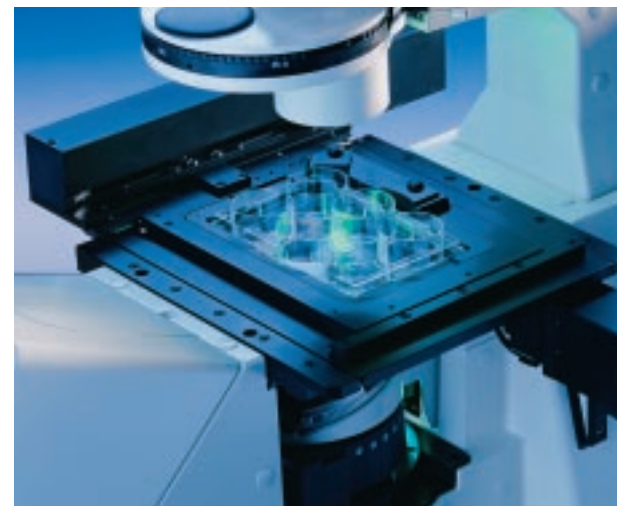
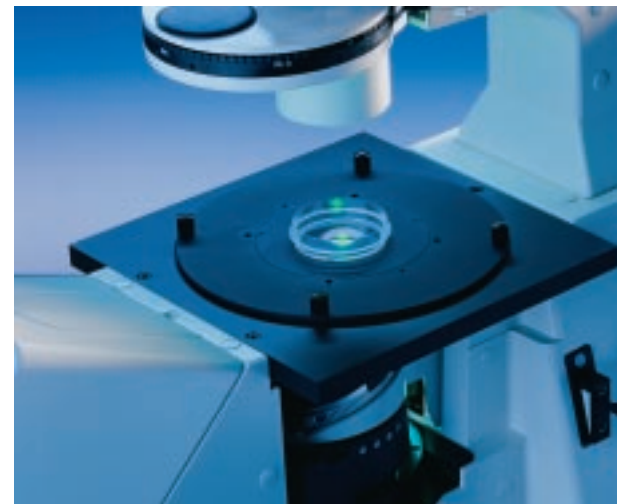
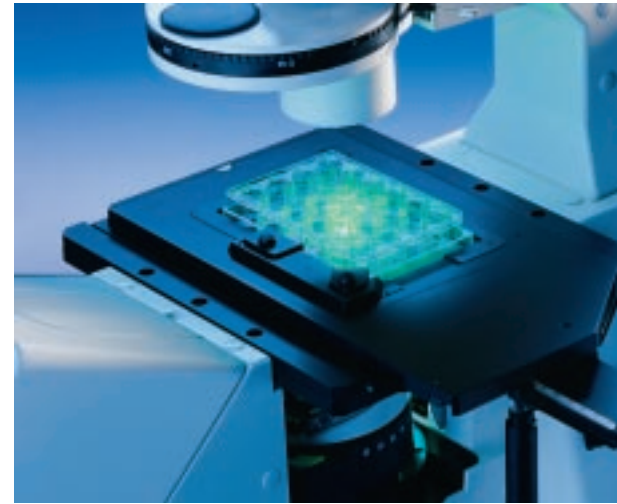
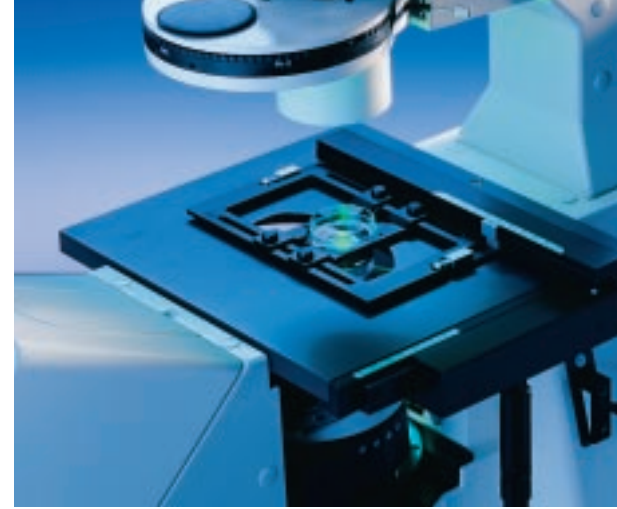

# Temperature Control and Incubation

## The Right Climate

Whether your specimen needs heating or cooling – Carl Zeiss has the facilities to optimize the environment for any experimental setup: Special heating and temperature controlled stages. Or, for upgrading a plain or mechanical stage: heatable and temperature controlled mounting frames are available.

The Carl Zeiss heating stage generates heat through transistor heat loss – without interfering electric fields. This is ideal for electrophysiology. In addition, the stage has ducts which direct a heated air blast under the specimen, right where it is needed.

An alternative way of temperature control is heat flow past the specimen within an incubator. This way, a temperature gradient cannot build up in the first place. The heating effect is supplemented by objective heaters which attach to immersion objectives. The heat is transmitted through the immersion oil right up to the specimen. In addition to the right temperature, constant pH is essential for optimum cell observation. This is ensured by incubation with CO<sub>2</sub>. Choose from the Carl Zeiss incubators shown on the right.



△ *Incubator XL:* This large incubator for all stages and various manipulators encloses most of the microscope. A generous number of doors provides easy access to the interior.

▽ *Incubator M:* Medium-size incubator for the plain and heating stages with attached object guide. Easy micromanipulation through an opening on the left side.



# Carl Zeiss - Digital Technology Intelligence in Light Microscopy

We all know that microscopy today could not exist without the support of computers – and that many applications would not even be feasible. Carl Zeiss has developed a tailor-made package of solutions comprising software with flexible modular components and a digital camera. In combination with the inverted high-end **Axiovert 200** microscope, this package provides you with the best basis for successful work in microscopy today.

## Everything Under Control: AxioVisionControl

All the motorized functions of your microscope perfectly controlled: Through its exceptional user-friendliness, AxioVisionControl is ideal for multi-user operations. Storing and recalling parameters for reproducible re-use, selection of contrasting methods, reflector cubes, objectives or complete adjustments – these are only a few of the operations that AxioVisionControl takes over for you. Fast and easy at the press of a button.

*Simple and clear operation of AxioVision software*

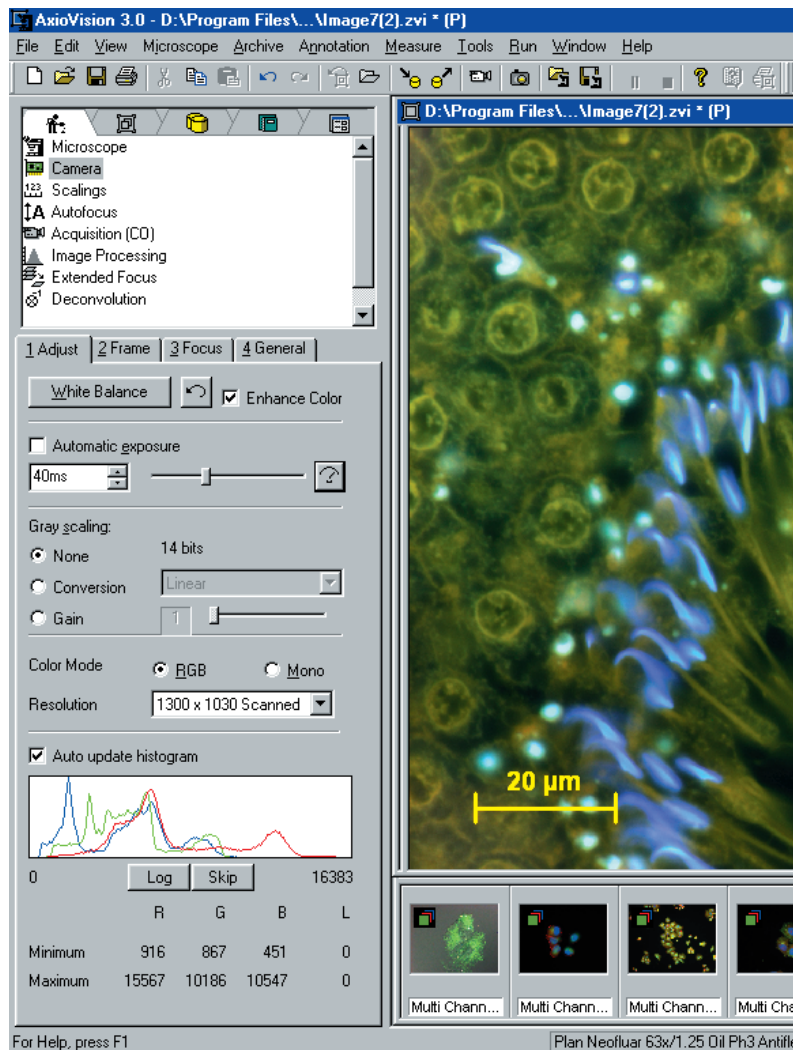

## Digital Top Performance: AxioVision

Convenient controls and precise image processing – that's what AxioVision, the digital imaging system from Carl Zeiss, offers you. From image acquisition, processing, annotation and archiving, to automatic storage and retention of

magnification factors or scale display when changing objectives right up to reports. Since its main window is divided into two areas, one for working and the other for documentation, AxioVision provides both easy-to-operate con-

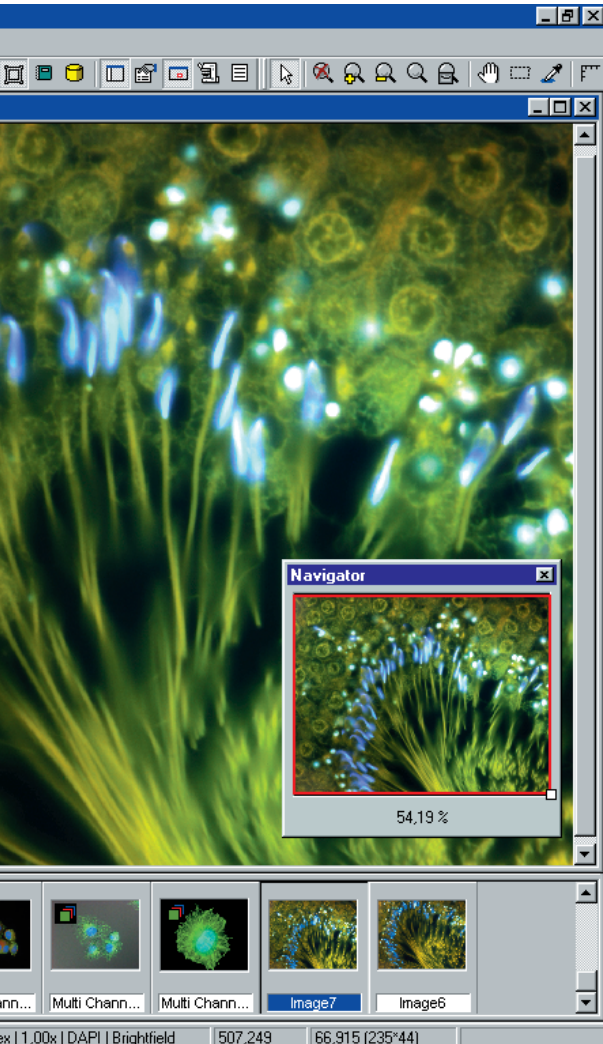

controls and optimal adaptation to individual applications. Moreover, it is possible to add on other helpful features. Additional modules provide you with even more possibilities to process and analyze images.

## AxioCam: The High-end Camera for a High-end Microscope

Perfect for every single one of your applications – the highly sensitive digital camera AxioCam enables you to exploit the full resolution capacity of **Axiovert 200**. With ultrahigh resolution up to 3900 x 3090 pixels in real color and high dynamics for high-quality fluorescence (14 bits per color channel), the cooled camera generates needle-sharp, color-fast images in all image formats. Even extremely fine structures are reproduced without color moiré. AxioCam is pleasantly easy to use. It works without an external control box and is absolutely vibration-free. With approximately 20 images per second on your monitor, the live mode is very rapid. You can focus precisely (in color!), look for the right place in the specimen and check exposure time. AxioCam, a real multitalent and an outstanding member of the **Axiovert 200** team. Available as AxioCam color, the superbly flexible color camera for transmitted light and fluorescence applications with high resolution. Or as AxioCam black& white with extra high sensitivity for such fluorescence applications as FISH or deconvolution.

*Division of a CHO cell.  
Bottom left: Original data  
Upper right: Result after deconvolution*

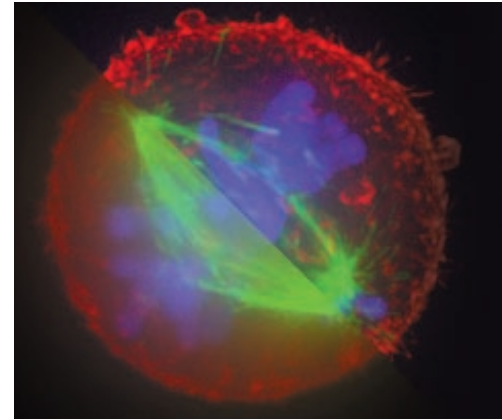

## Optimal Fluorescence: Deconvolution from Carl Zeiss

You are only too well familiar with this problem in fluorescence microscopy: stray light from above and below the focal plane. Your image is over-exposed – to the extent that in the worst of cases you no longer recognize any structures. The powerful software solution from Carl Zeiss can calculate the interfering stray light right back to the point of origin. As a consequence, the distorted structure “straightens out”. With the help of Z-stack modules and 3-D deconvolution, AxioVision takes care of everything. First, the control and regulation of microscope and camera in capturing the Z-stacks. Second, calculating the degree of distortion (PSF – Point Spread Function). Third, the deconvolution method. The result is significant increases in contrast and sharper, clearer images. Fast and easy.

# Carl Zeiss - Live Cell Imaging

## Seeing Life Through New Eyes

Bordering on *In Vivo* reality – experiments with living cells and tissues are confronting researchers with real challenges. Cell Observer is the first complete solution for the observation and digital documentation of living processes. Ready for use, and rigorously tailored to the exacting requirements made by the varying applications in live cell imaging. And there's another big plus: Since Cell Observer is easy to operate and user-friendly, even beginners can benefit from its many top-of-the-line features. The best basis for outstanding success in cell and molecular biology.

### **Focus on Perfect Teamwork: The Components**

Cell Observer is the first powerful, complete and homogeneous live cell imaging system. A combination of perfectly matched components, designed to meet all demands. The system consists of: a Zeiss microscope, the Zeiss digital camera AxioCam, the Zeiss software system AxioVision as well as Zeiss accessories such as x,y-stages, filter wheels, shutters, incubators and culture chambers.

### **All in One: The Functions**

Documenting dynamic processes with time-lapse, multi-channel, z-stack and Mark&Find in freely selectable combinations – Cell Observer offers you everything in one system. Including such practical features as the possibility to

alter all parameters even while recording through "Pause" and "Continue" functions. Or measuring the distance from A to B, calculating the angle between A, B and C, statistics and much, much more. In a nutshell: All the features that you expect and need in modern live cell imaging.





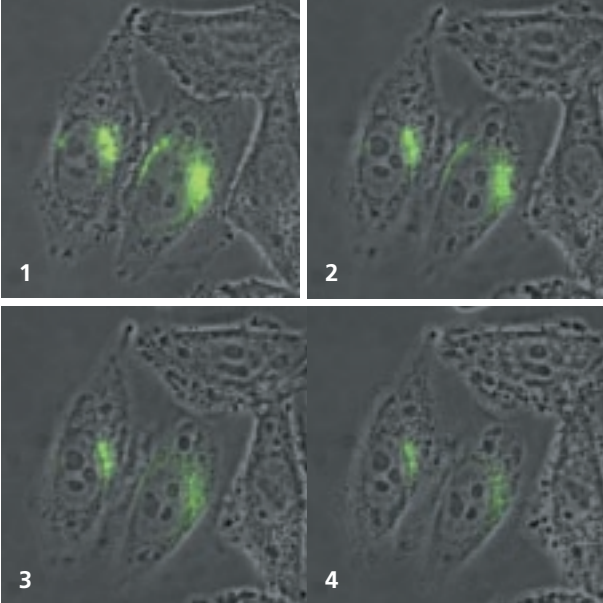

Central control of the most important adjustments for multidimensional imaging

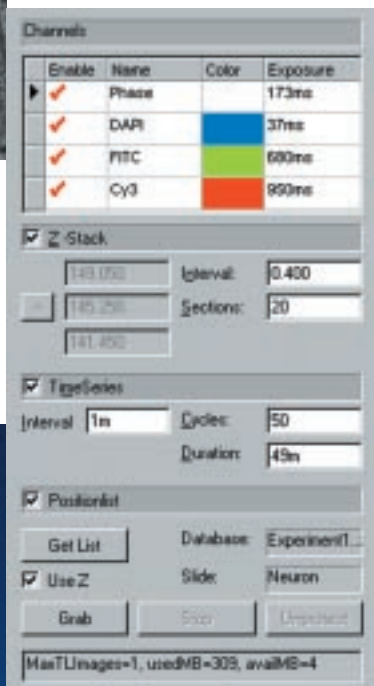

HeLa cells in phase contrast and GFP fluorescence (Golgi markings). Dissociation of Golgi apparatus according to Brefeldin A Zugabe. Dr. Pepperkok, EMBL Heidelberg, Germany

## New Dimensions: The Performance

When you go beyond the second and third dimensions, you see with striking clarity the new dimensions in performance that Cell Observer offers you. The information found in the fourth wavelength dimension can be stored in 8 different channels of the image and freely combined at any time. The fifth time dimension describes the recording of cells during a defined period of time. In the sixth dimension various positions are automatically brought into focus on the culture plate. Whether you're working in 2-D or in high-end 6-D imaging, with 6 images or 600: Cell Observer enables you to experience totally new dimensions in live cell imaging.

Axiovert 200 with scanning stage and Incubator S which is attached to the heating insert P for mechanical and scanning stages. Advantage: small volume, significantly reduced CO<sub>2</sub> consumption, imaging of diverse cell culture chambers, ideal for long-term experiments

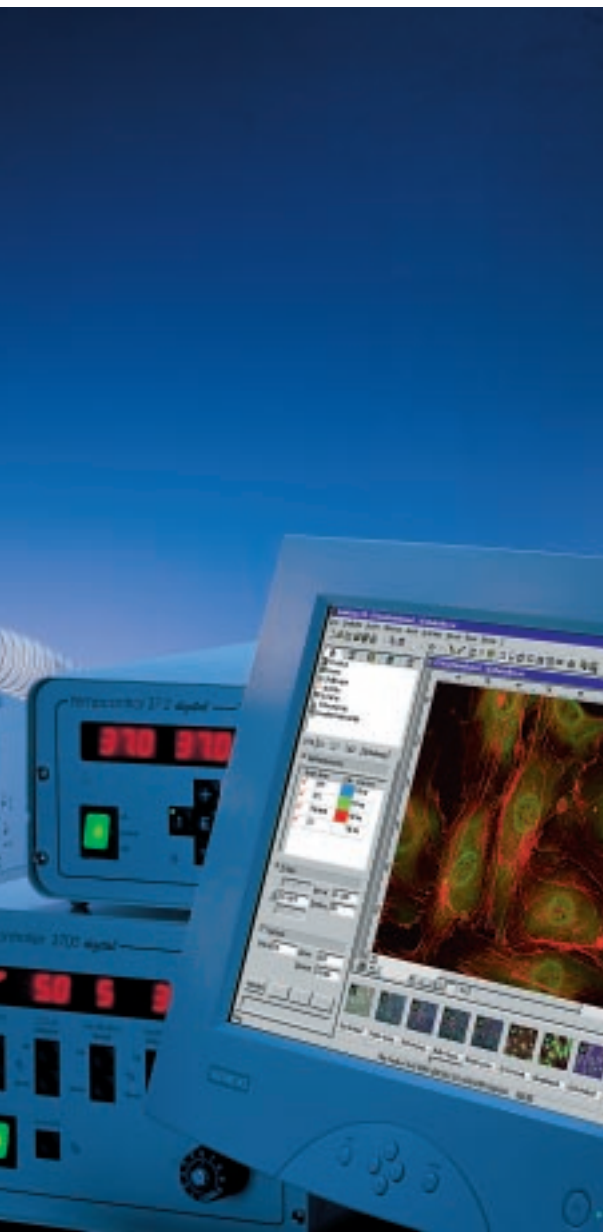

## Cell Observer: The Applications

### Transmitted Light

- Observation over time
- Observation over time with interruptions and manipulation
- Observation over time with motorized x,y-stage
- Observation over time of dynamic processes
- Observation over time Z-stack

### Fluorescence

- Observation over time in up to 8 channels (fluorescence or transmitted light)
- Observation over time in up to 8 channels with interruptions and manipulation
- Observation over time in up to 8 channels with motorized x-, y-stage
- Observation over time in up to 8 channels with Z-stack

# Axiovert 200 M - Laser Scanning Microscopy

## See More, Recognize More

To give you an edge in your biomedical research, use the **Axiovert 200** top-of-the-line research microscope as part of your confocal system.

The optics and mechanics of the **Axiovert 200** have been designed to integrate effortlessly into the Zeiss LSM 510 confocal microscope and its "little brother" the LSM 5 PASCAL. For outstanding resolution in all dimensions, LSM 510 and LSM 5 PASCAL are your ideal partners. Their powerful performance is still unequaled.

### **Growing with Your Requirements: The LSM Family**

The LSM 5 PASCAL is an the ideal entry-level confocal microscope – a powerful but budget-priced system that sets new standards in its class. The LSM 5 PASCAL is the microscope of choice when you need a wide spectrum of fluorescence applications, including DIC contrast images. And its "big brother", the powerful Zeiss LSM 510, offers even more possibilities. With up to four fluorescence channels simultaneously, and a wide choice of lasers to excite dyes in the UV and VIS range. LSM 510 NLO is perfect for the long-term observation of cells, tissues and

embryos. Its multiphoton technology guarantees excellent imaging even with thicker samples. And its high 3-D selectivity enables you to conduct bleaching experiments such as FRAP and uncaging locally in addition to flexible image acquisition.

### **Efficient and Easy on the Sample: Flexibility of Application**

No other LSM system offers you so many different scanning methods: scan along a freehand drawn line, complete 360° image rotation, zoom and offset. In addition you have standard and special modes such as spline scan or Real Region of Interest (ROI) scan. Even complex time series can easily be defined and captured – with special attention paid to careful handling of your samples. All processes can be recorded and stored as digital movies. Thanks to the multitasking features these LSM systems offer, you can acquire multi-channel fluorescence images without channel crosstalk. All of this underscores the philosophy behind Zeiss LSM technology: noise-free images with a minimum of effort.

### **Intelligent Features: The Intuitive Software**

The sophisticated and continually expanding LSM software can do far more than record brilliant images. Measurement functions are available to evaluate your data while an entire series of different 3-D and 4-D visualization features provide you with totally new



insights into the structure of your samples. Numerous online and offline evaluation features analyze time series. The extremely user-friendly LSM image database stores not only image data but also all relevant parameters, including your notes. And because the system is completely motorized, reproducing an experiment under identical conditions is only a mouse click away. This makes the work significantly easier and saves more than just time.

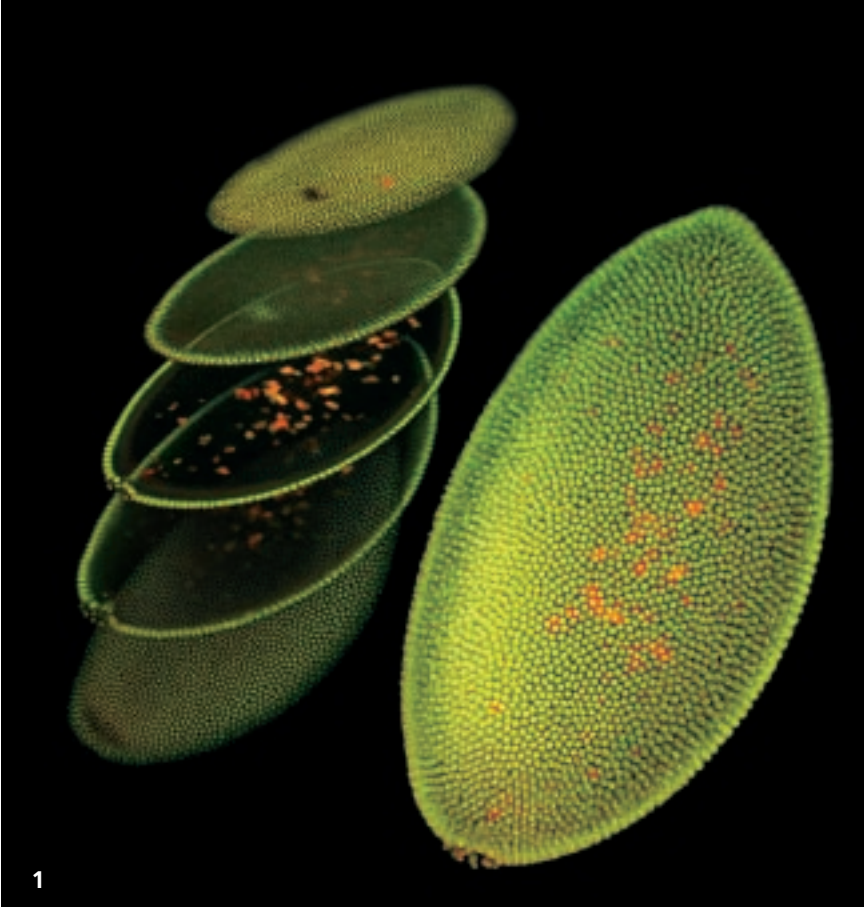

1

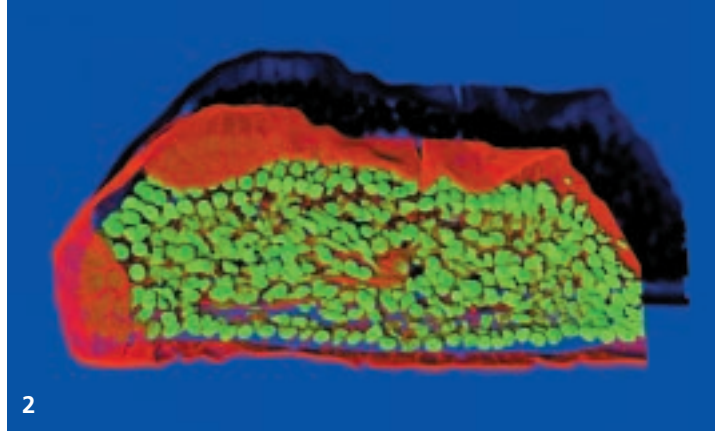

2

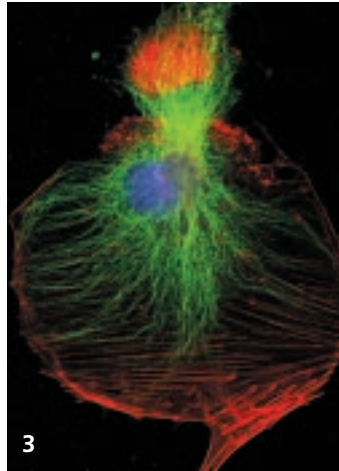

3

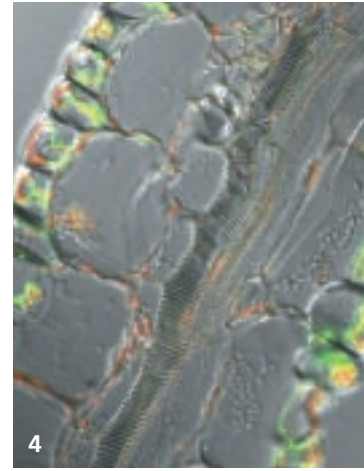

4



- 1) *Drosophila* embryo, optical sections (slices) and projection of a stack of 47 images. Cell nuclei (propidium iodide), chromatin protein (FITC).
- 2) Mouse intestine section, double fluorescence, 3-D shadow projection
- 3) Bovine endothelial cells, triple fluorescence, nucleus (DAPI) F-actin (BODIPY-FL) mitochondria (Mitotracker Red)
- 4) Leaf tissue with vascular bundle, double fluorescence and differential interference contrast (DIC)

**Molecular Interactions Efficiently Analyzed: ConfoCor 2**

Universal for solutions, unbeatable for cells: with the LSM 510 you can localize marked molecules. Using fluorescence correlation spectroscopy (FCS), ConfoCor 2 helps you to understand the interactions between these molecules. The measuring volume is, smaller than an *E. coli* bacterium and fits in every cell. As a result, biochemical processes can be examined in their natural environment. Of course, you can also use ConfoCor 2 for measurements in solutions.

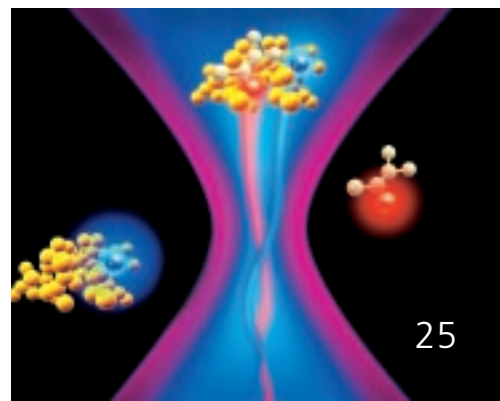

# Axiovert 200 - A Partnership for the Future



## Ideally Suited for the Perfect Handshake: Zeiss Partners

Whenever you need special software for your applications, remember: Your partners are our partners. **Axiovert 200's** open architecture makes it easy for you to effortlessly link software packages from other suppliers. Which of course makes **Axiovert 200** the ideal platform for a wide range of special application driven software in many areas of research.

## That Extra Plus in Performance: Zeiss Service

The decision you make for a microscope, one equipped with the components you need, is as complex as the requirements it must meet. A skilled team of consultants will help you with making the right choice and with budget planning. And all of our consultants possess impressive know-how and experience as well as extensive knowledge of the entire microscope market. Thus you benefit from much more than our skill in developing microscopes. You will be able to draw upon the enormous wealth of experience that Zeiss has accumulated in decades of practice in research and routine. You will profit from concrete assistance in your microscopy methods – and above all from innovative methods which will

enable you to make great progress in your work. As a matter of fact, you often can't really appreciate the full range of Zeiss service until after you have made your purchase – in practice, which is what counts. Our local consultants and technicians and the Carl Zeiss customer service all support you in your research with technical and applications aid, whenever you need it. Fast and reliably. Moreover, Carl Zeiss training courses and workshops provide you with added insights into practical areas of microscopy and imaging techniques. In fact, when you add together all the services and support that you get with **Axiovert 200**, you'll see that it is more than a high-power microscope:

**Axiovert 200** is your ticket to a powerhouse of knowledge in microscopy that has been built up over the past 150 years.



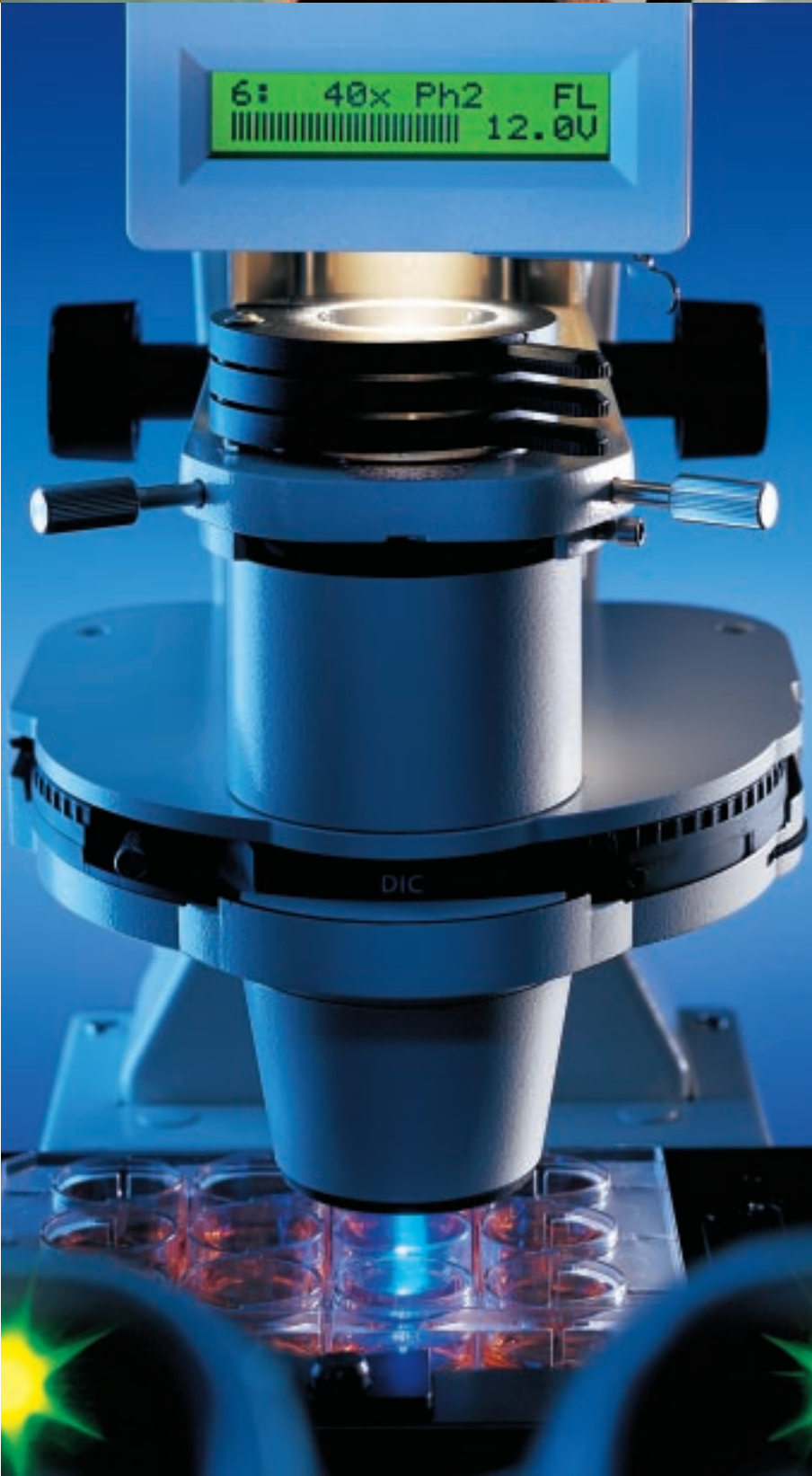

**Convincing from A - Z**

Accessible	the diaphragm planes
Complete	system solutions from a single source
Confocal	with LSM 510
Contrast-enhancing	the Light Trap
Convenient	the Light Manager
Customized	the modular system
Digital	AxioVisionControl software
Easy to use	the Push&Click filter cubes
Efficient	the motorized features
Ergonomic	the Ergotube
Flexible	the Dual Video Adapter
Generous	the working distances of the LD Condensers
Highly resolved	DIC (even with Sénarmont)
Ideal	the documentation ports
Individual	the function buttons
Informative	the LCD display
N-dimensional	the modular Cell Observer
Open-end	the system architecture
Optimal	the stages and incubators
Powerful	the ICS optics
Precise	the Harmonic Drive motor
Retrofittable	systems for micromanipulation
Sturdy	the mechanics
Versatile	5 filter positions with 23 mm field of view
Vibration-free	the SoftStop function
Water-proof	the Aqua Stop
Zappy	the electric shutter

# Technical Data

## Compare and Decide

	<b>Axiovert 200</b>	<b>Axiovert 200 M</b>
<b>Microscope stand</b>	Highly stable pyramid shape and low center of gravity for vibration-free work, min. 8 adaptation options (18 drilled holes) e.g. for micromanipulators	
<b>z-Focus</b>	Harmonic Drive  Ratio Coarse: Fine = 50:1	Motorized Harmonic Drive, minimum step size: 25 nm Ratio Coarse: Fine = 10:1, individually adjustable for every objective
<b>Optics</b>	ICS – Optics for best image quality Special objectives with long working distance: LD A-Plan and LD Achroplan	
	6x objective nosepiece for DIC, encoded	6x objective nosepiece for DIC, motorized
<b>DIC System</b>	Nomarski DIC – for every objective the optimal DIC slider, contrast adjustment optional with Sénarmont with an analyzer and rotary $\lambda/4$ plate	
<b>Illumination</b>		
Transmitted light	6 V, 30 W	
	12 V, 100 W with on/off switch on the front of the stand, Köhler illumination	
	LCD display, Light Manager	
Epi-fluorescence Filter slider	3 positions for filters with 25 mm diameter	
Diaphragm slider	Optional, centerable for aperture and luminous-field diaphragms for Köhler illumination in incident light	
Reflector turret	5 positions, manual, exchangeable on both sides	5 positions, manual or motorized, exchangeable
Shutter, electric	Fast and easy-to-use shutter on the front of the stand	
Light Trap	Best signal to noise ratio, very good contrast, minimised stray light	
Push&Click filter cube	Fast and precise change of filter cubes	
Adjusting aid	Easy adjustment of the HBO burner	
<b>Tubes</b>		
Binocular tube	With shutter to avoid stray light through overhead light	
Phototube	With shutter and focusing Bertrand optics for easy adjustment of Ph apertures	
Ergotube	With shutter and focusing Bertrand optics for easy adjustment of Ph apertures	
<b>Eyepieces</b>		
PL 10x/23	23 mm field of view. Budget model, sufficient if mainly cameras are used for observation	
E-PL 10x/23	23 mm field of view. For high-quality observation	
<b>Stages</b>		
Specimen stage (250x230mm)	With object guide for right and left, travel range: 130 x 85 mm with assorted frames	
Mechanical stage	Plane surface, large travel range: 130 x 85 mm with application-oriented specimen holders	
Sliding stage (Z)	For precise and free positioning, especially in micromanipulation (e.g. for transgenic techniques)	
Scanning stage, motorized	Travel range: 120 x 100 mm with specimen holders (like mechanical stage)	

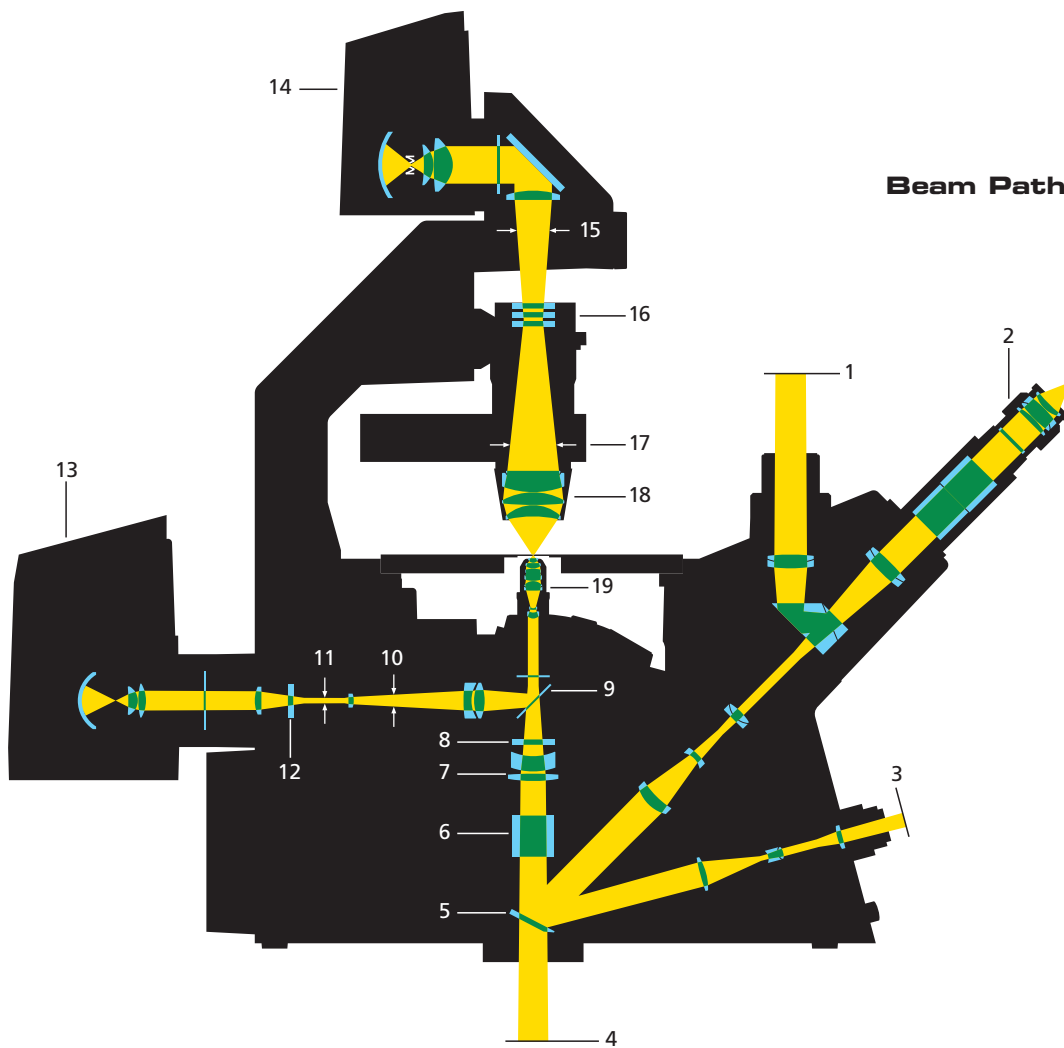

**Beam Path**

- 1 intermediate image plane phototube
- 2 eyepiece
- 3 intermediate image plane frontport
- 4 intermediate image plane baseport
- 5 beam path switching between baseport/ frontport/vis
- 6 sideport prisms
- 7 tube lens
- 8 analyzer
- 9 reflector module
- 10 luminous field diaphragm
- 11 aperture diaphragm
- 12 filter slider
- 13 HBO lamp
- 14 HAL lamp
- 15 luminous field diaphragm
- 16 polarizer
- 17 aperture diaphragm
- 18 condenser
- 19 objective

	<b>Axiovert 200</b>	<b>Axiovert 200 M</b>
<b>TV Ports</b>		
Side port	Splitting:	
2x left	100vis:0%doc/20vis:80doc	
3x left	100vis:0%doc/50vis:50doc/0%vis:100%doc	The same like Axiovert 200, but motorized
3x right	100vis:0%doc/50vis:50doc/0%vis:100%doc	The same like Axiovert 200, but motorized
3x right + left	100vis:0%doc/0vis:100doc left/20%vis:80%doc right	The same like Axiovert 200, but motorized
Front port	Adapter for digital cameras, optional	
	Adapter for SLR cameras, optional	
Base port	Optional	
Dual Video Adapter	For every interface 60, with two ports (one adjustable in x,y,z) and exchangeable beam splitter	
<b>Condenser</b>		
N.A. 0.35 W.D.* = 70 mm	For BF, Ph0, Ph1, Ph2, DIC	
N.A. 0.35 W.D.* = 70 mm	For BF/DIC, Ph0, Ph1, Ph2, VAR1	
N.A. 0.55 W.D.* = 26 mm	For BF, Ph1, Ph2, Ph3, DIC, DIC, manual	For BF, Ph1, Ph2, Ph3, DIC, DIC, motorized
N.A. 0.55 W.D.* = 26 mm	For BF/DIC, Ph1, Ph2, Ph3, VAR1+2	
N.A. 0.8 W.D.* = 7 mm	For BF/DIC, Ph1, Ph2, Ph3, D	
N.A. 1.4 Oil Imm.	For BF, Ph, DIC	
<b>Aqua Stop</b>	For protection of nosepiece from spilled liquids	

\* with working distance

# Axiovert 200

**Mounting frames for specimen stage with object guide**

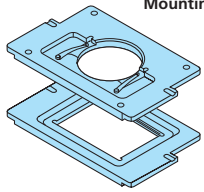

**Mounting frame M for specimen slider 76 x 26**  
471719-0000-000

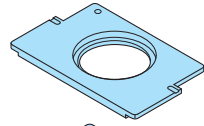

**Mounting frame M for microtest plates**  
471747-0000-000

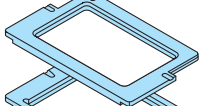

**Mounting frame M for Petri dishes, dia. 36 mm**  
471742-0000-000

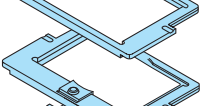

**Mounting frame M for Petri dishes, dia. 54 mm**  
471743-0000-000

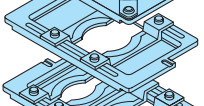

**Mounting frame M for Petri dishes, dia. 65 mm**  
471758-0000-000

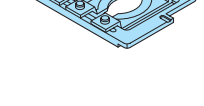

**Mounting frame M for Petri dishes, dia. 88 mm**  
471759-0000-000

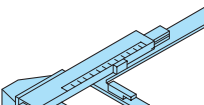

**Mounting frame M for microtiter plates 96 positions**  
471746-0000-000

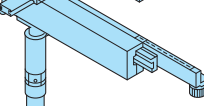

**Mounting frame M for multitest dishes**  
471744-0000-000

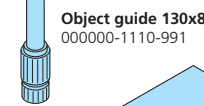

**Universal mounting frame M-X**  
471717-0000-000

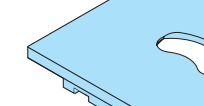

**Universal mounting frame M**  
471718-0000-000



**Universal mounting frame M-Duo**  
000000-1116-077

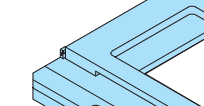

**Specimen stage 250x230 mm**  
000000-1005-832

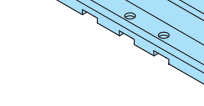

**Mechanical stage 130x85 R/L without mounting frames**  
000000-1005-834

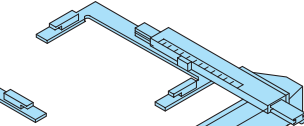

**Object guide 130x85 mm right**  
000000-1005-833

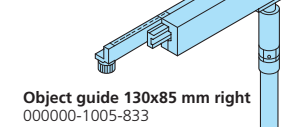

**Object guide 130x85 mm left**  
000000-1110-991

**Simple gliding stage with stage inserts d=24 and 48mm**  
471720-0000-000

**Gliding stage Z with stage inserts d=24 and 48mm**  
471722-0000-000

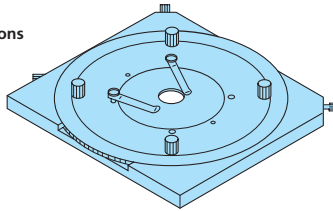

**Object mount for two Petri dishes "35" or one object carrier (PC)**  
000000-1116-088

**Auxiliary microscope d=30**  
000000-1006-362

**Eye-piece eyecup**  
444801-0000-000

**Eye-piece E-PL 10x20 Br.**  
444231-9901-000  
**Eye-piece E-PL 10x20 Br. foc**  
4444232-9902-000  
**Eye-piece W-PL 10x23 Br. foc**  
000000-1016-758

**Binocular phototube with sliding prism 45°/23**  
000000-1005-828

**Binocular tube 45°/23**  
000000-1005-827

**Binocular ergotube 25°/23**  
000000-1005-829

**Mounting frames for mechanical stage**

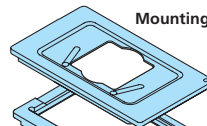

**Mounting frame K**  
451341-0000-000

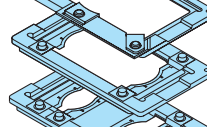

**Universal mounting frame K-X**  
451353-0000-000

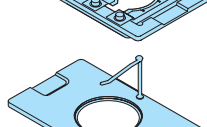

**Universal mounting frame K**  
451352-0000-000

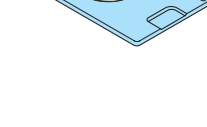

**Universal mounting frame K-Duo**  
000000-1116-078



**Mounting frame K, d=72mm**  
451344-0000-000

**Stage stop d=28 mm**  
451345-0000-000

**DIC prism I/0.35**  
000000-1005-821  
**DIC prism II/0.35**  
000000-1005-822

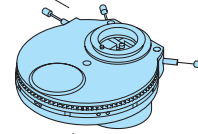

**LD condenser 0.35 H/DIC, Ph 0, Ph 1, Ph 2, Var 1**  
000000-1005-844

**LD condenser 0.35 H, Ph 0, Ph 1, Ph 2, DIC, DIC**  
000000-1005-845



**Achromatic condenser 0.8 H, DIC**  
000000-1087-444

**DIC prism III/0.8**  
000000-1087-445

**TV-adaptor**  
acc. price list

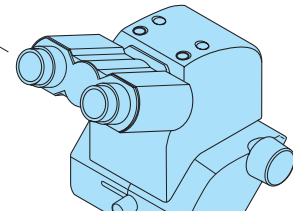
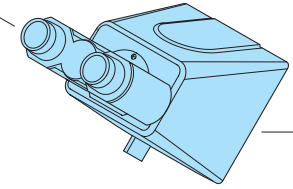
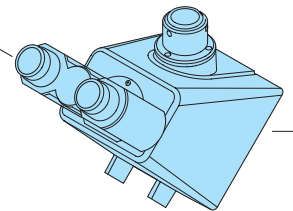



**DIC prism I/0.55**  
000000-1005-866

**DIC prism II/0.55**  
000000-1005-867

**DIC prism III/0.55**  
000000-1005-868

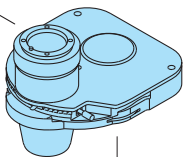

**Conversion filter**  
3200-5500 K, d=32x2  
467847-0000-000

**Interference wide-band filter**  
green, d=32x4  
467803-0000-000



**LCD display and light manager**  
000000-1071-167



**100 HAL lamp housing with collector, lamp mount**  
447219-0000-000

**12 V 100 W Halogen lamp**  
380079-9540-000

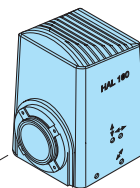

**LD condenser 0.55 H/DIC, Ph 1, Ph 2, Ph 3, Var 1/2**  
000000-1005-846

**LD condenser 0.55 H, Ph 1, Ph 2, Ph 3, DIC, DIC**  
000000-1005-847

**Polarizer D**  
000000-1005-864



**Polarizer D, rotatable**  
000000-1121-813



**Carrier for transmitted-light illumination and condenser**  
000000-1005-840

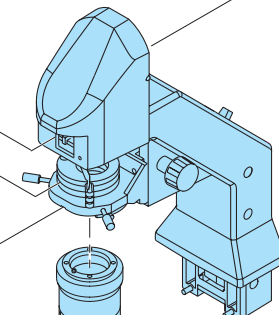

**DIC prism III/0.8**  
445485-0000-000

**DIC prism II/1.4**  
445375-0000-000

**DIC prism III/1.4**  
445376-0000-000



**Condenser mount for condensers 0.8/1.4**  
000000-1005-849

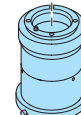

**Achromatic condenser 0.8 H, D, Ph, DIC**  
445445-9901-000

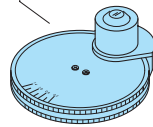

**Achromatic-aplanatic condenser 1.4 H, D, Ph, DIC**  
445453-0000-000

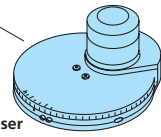

**Control PC-board**  
000000-1015-348

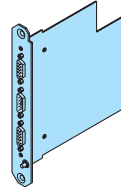

**Control PC-board with interface**  
000000-1015-381

**Aqua Stop**  
000000-1109-740

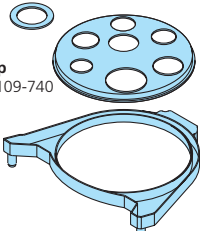

**Cover glass cup**  
000000-1016-757

**Objectives**  
acc. price list



**Antiglare screen for "Axiovert" 200**  
000000-1109-741

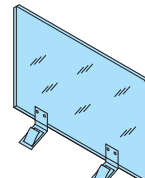

**Cable release**  
416167-0000-000



**Axiovert 200 basic stand**  
000000-1005-813

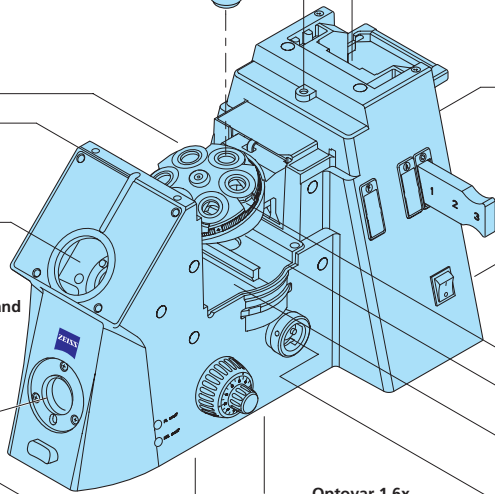

**Analyzer slider, fixed**  
000000-1005-862

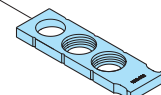

**Analyzer slider +/- 30°**  
000000-1005-863

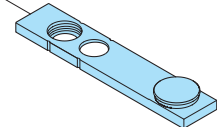

**DIC slider**  
acc. price list



**Single-lens reflex camera housing Contax Aria (D)**  
000000-1057-127

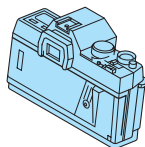

**T2-adapter for Contax (Contax-Bayonet)**  
416010-0000-000

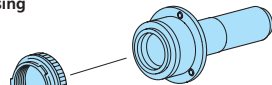

**Adapter V200 T2 2.5x for SLR at frontport**  
000000-1005-869

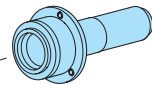

**Optovar 1.6x**  
000000-1005-855

**Optovar 2.5x**  
000000-1005-856



**Baseport 60**  
000000-1005-824



**Adapter Video V200 C 2/3" 0.63x at frontport**  
000000-1071-171

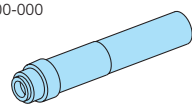

**High Resolution Microscopy Camera AxioCam b/w**  
000000-0412-311

**High Resolution Microscopy Colour Camera AxioCam Colour**  
000000-0412-312

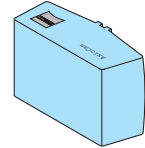

**Path deflection to the tube**  
000000-1069-227

**Beam path switching**  
000000-1069-228

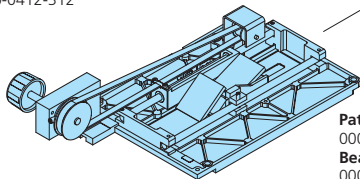

**Sideport 60 left, 2 switching positions**  
000000-1005-815

**Sideport 60 left, 3 switching positions**  
000000-1005-816

**Sideport 60 right, 3 switching positions**  
000000-1005-817

**Sideport 60 left and right, 3 switching positions**  
000000-1005-818

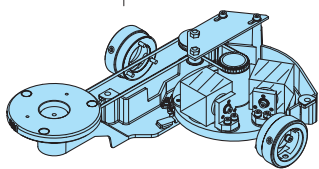

**Double video adapter**  
000000-1058-640

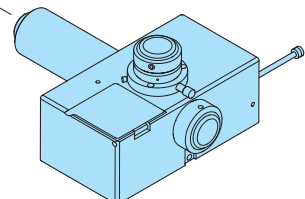

Phase stop Ph 0/0.22  
451261-0000-000

Phase stop Ph 1/0.2  
451260-0000-000

Phase stop Ph 0/0.4  
451255-0000-000

Phase stop Ph 1/0.4  
451256-0000-000

Phase stop Ph 2/0.4  
451257-0000-000

Phase stop Ph 1/0.55  
451258-0000-000

Phase stop Ph 2/0.55  
451259-0000-000

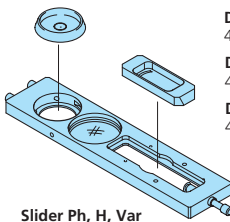

Slider Ph, H, Var  
451246-0000-000

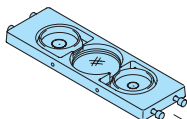

Slider Ph, H, Ph  
451245-0000-000

Diaphragm Var 1/0.4  
451251-0000-000

Diaphragm var 1/0.55  
451252-0000-000

Diaphragm Var 2/0.55  
451253-0000-000

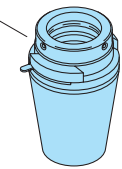

Condenser 0.2  
451236-0000-000

Condenser 0.55  
451237-0000-000

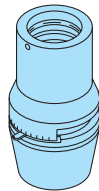

Condenser 0.4  
451235-0000-000

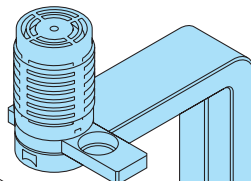

Carrier for 6V 25/30W  
transmitted-light illumination  
451380-0000-000

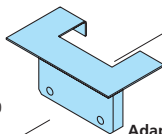

Adapter for carrier for 30W  
transmitted-light illumination  
000000-1005-842

for external power supply HAL

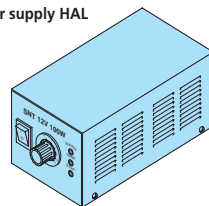

Power supply 12V DC 100W stabilized  
000000-1128-574

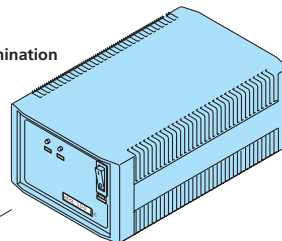

Power supply unit for N HBO 103  
90...250V, 50...60Hz, 265 VA  
000000-1003-928

Adjusting aid for HBO/XBO  
452369-0000-000

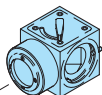
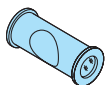

Path-deflecting mirror  
for two illuminators  
447230-9901-000

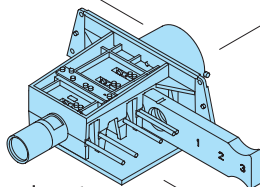

FL incident-light equipment  
000000-1066-230

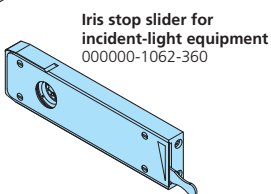

Iris stop slider for  
incident-light equipment  
000000-1062-360

Protection filter for reflector turret  
000000-1068-113

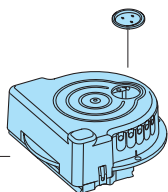

5-position reflector turret, empty  
000000-1064-364

Reflector module Pol P&C  
000000-1046-279

Reflector module FI P&C  
000000-1046-281

Analyzer module D P&C  
000000-1050-958

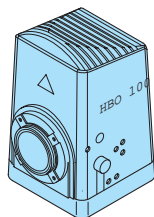

Illuminator N HBO 103  
000000-1007-980

Collector N HBO 103/XBO 75  
000000-1007-976

Achromatic collector  
000000-1007-978

Mercury vapor short-arc lamp HBO 103 W/2  
380301-9350-000

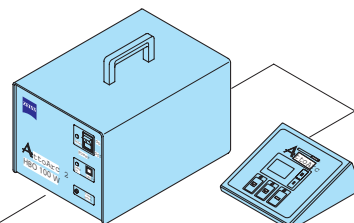

Variable intensity lamp control AttoArc 2 N HBO  
000000-1007-975

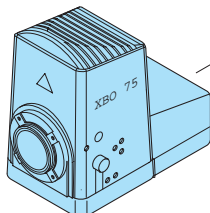

Illuminator N XBO 75  
000000-1007-981

Collector N HBO 103/XBO 75  
000000-1007-976

Achromatic collector  
000000-1007-978

Xenon lamp XBO 75 W/2  
380053-9870-000

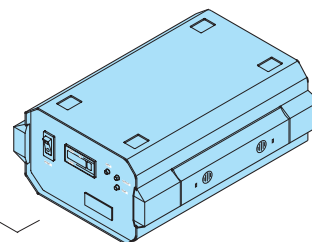

Power supply unit for N XBO 75  
90...250V, 50...60Hz, 130 VA  
000000-1003-924



Protective gloves  
417008-0000-000



Face protection shield  
417009-0000-000

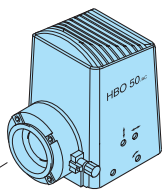

Lamp housing HBO 50 with socket  
447220-0000-000

Lamp collector HBO 50/SF 25  
447270-0000-000

HBO 50 super-pressure mercury lamp  
381619-0000-000

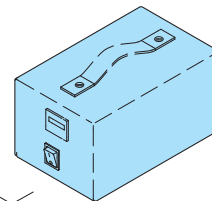

Power supply unit for HBO 50,  
100...240 V, 50...60 Hz, 350VA  
000000-1113-833

**System Overview**

# Axiovert 200 M

**2-axes control panel**  
457433-0000-000

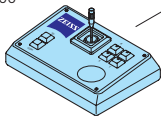

only together  
with LSM 510:  
**HRZ 200 fine focusing stage**  
000000-1013-186

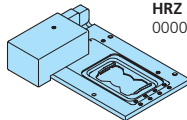

**Dust cover**  
459330-0000-000

**Motor control MCU 28**  
457428-0000-000

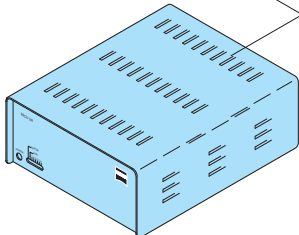

**CAN bus cable 2.5 m**  
457411-9011-000

**Scanning stage DC 120x100**  
000000-1113-509

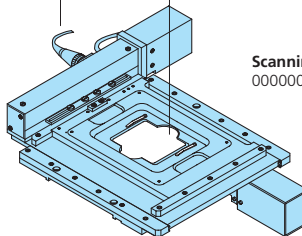

**Path-deflecting mirror mot, Subbus**  
000000-1095-490

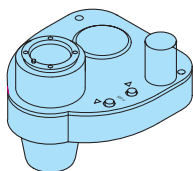

**LD condenser 0.55 mot H, Ph 1, Ph 2, Ph 3, DIC, DIC**  
000000-1005-848

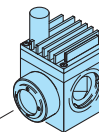

**Excitation filter wheel  
(8 positions) MOT  
for 25 mm filters**  
000000-1008-106

**Axiovert 200 M basic stand (\*)**  
000000-1005-820  
**AxioVision Control Software**  
000000-1068-563  
**RS 233 cable**  
457411-9a012-000

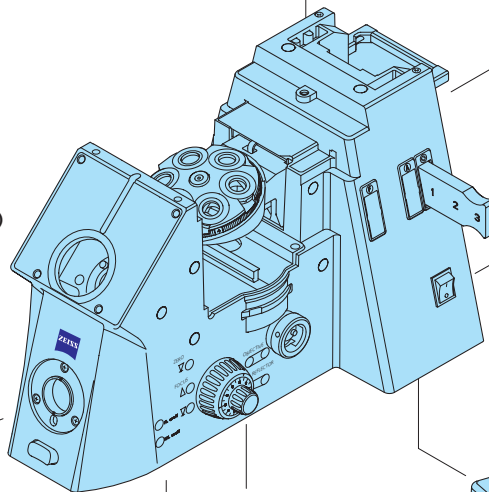

**Control PC-board with interface**  
000000-1015-381  
(contained in basic stand)

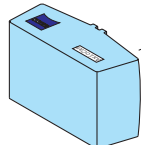

**Adapter Video V200 C 2/3" 0.63x  
at frontport**  
000000-1071-171

**High Resolution Microscopy Camera AxioCam b/w**  
000000-0412-311  
**High Resolution Microscopy Colour Camera AxioCam Colour**  
000000-0412-312

**Tube lens 1.0 for LSM**  
000000-1071-169

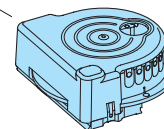

**5-position mot. reflector turret, empty**  
000000-1064-365  
**5-position reflector turret, empty**  
000000-1064-364

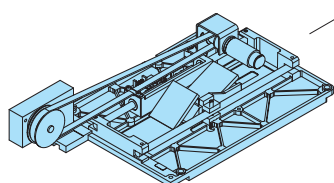

**Beam path switching mot**  
000000-1069-229

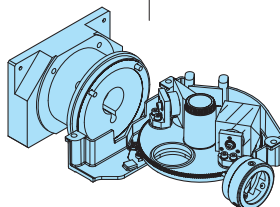

**LSM-adapter SP left and sideport 60 right, 3 switching positions**  
000000-1071-164  
**LSM adapter BP and sideport 60 left, 3 switching positions**  
000000-1071-165  
**LSM adapter BP and FCS adapter SP left, 3 switching positions**  
000000-1071-166  
**Safety installations LSM 510/PASCAL**  
000000-1071-174  
**Beam path switching mot LSM**  
000000-1069-230

(\*) If there are no special motorized components, all components of the manual stand can also be used at the motorized stand.

# Axiovert 200

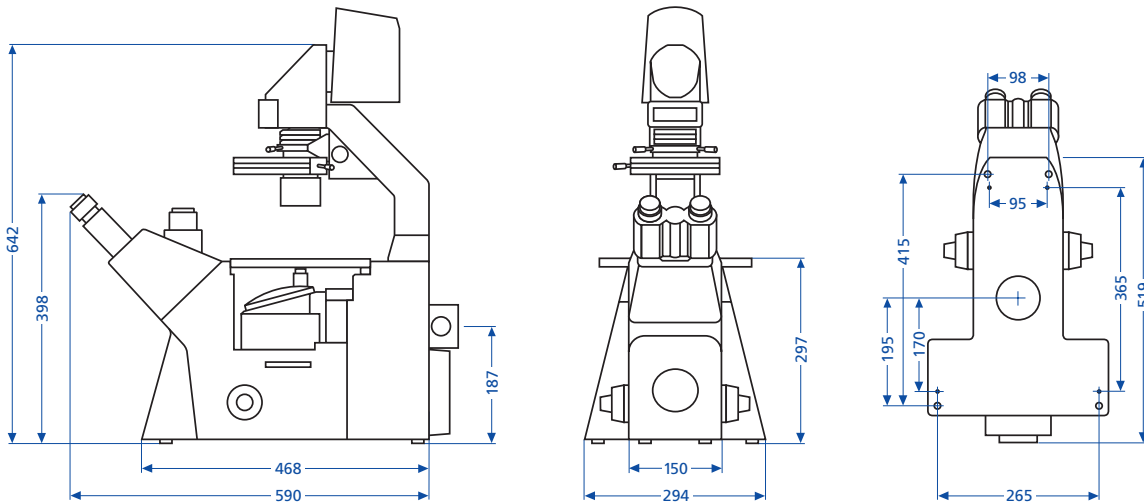

Weight: Axiovert 200 ca. 24 kg (depending on model)  
Axiovert 200 M ca. 40 kg incl. fluorescence

For further details, please contact:

## Carl Zeiss Light Microscopy

P.O.B. 40 41  
37030 Göttingen  
GERMANY  
Phone: ++49 5 51 50 60 660  
Telefax: ++49 5 51 50 60 464  
E-Mail: [micro@zeiss.de](mailto:micro@zeiss.de)

[www.zeiss.de/micro](http://www.zeiss.de/micro)

Subject to change.

AxioCam and Light Trap are trademarks of Carl Zeiss.  
Axiovert, AxioVision, LSM 5 PASCAL and Optoviar is a registered trademark of Carl Zeiss.

