

## Specifications

	TS100	TS100-F
<b>Main body</b>		
<b>Optical system</b>	CFI60 Infinity Optical System	
<b>Illumination</b>	<ul style="list-style-type: none"> <li>High luminescent white LED illuminator (Eco-illumination)</li> <li>6V30W halogen lamp, Built-in heat absorbing filter and diffuser, 2 filters (45-mm NCB11, ND8, GIF) mountable with filter frame, Compliant multi-voltage (100 V-240 V)</li> </ul>	
<b>Eyepieces (F.O.V.)</b>	<ul style="list-style-type: none"> <li>C-W 10x (22 mm)</li> <li>C-W 15x (16 mm)</li> </ul>	
<b>Focusing</b>	Vertical objective movement, Coaxial coarse/fine focusing, Focusing stroke: 22 mm, Coarse: 37.7 mm/rotation, Fine: 0.2 mm/rotation, Coarse motion torque adjustable	
<b>Tubes</b>	Binocular tube (within main body)	Trinocular tube (within main body), Eyepiece/Port: 100/0, 0/100
<b>Nosepieces</b>	Quintuple nosepiece (within main body), Backward-facing type	
<b>Stages</b>	<ul style="list-style-type: none"> <li>Plane stage (within main body), Stage size: 170 (X) x 225 (Y) mm, Stage height: 195 mm from table, Auxiliary stage attachable</li> <li>Mechanical stage (optional), Stage movement: 126 (X) x 80 (Y) mm, Accepts several types of micro-testplate holders</li> </ul>	
<b>Holders</b>	ø35-mm Petri Dish Holder, Universal Holder, Terasaki Holder (accepts ø65-mm petri dish), Slide Glass Holder (accepts ø54-mm petri dish), Hemacytometer Holder	
<b>Condensers*</b>	<ul style="list-style-type: none"> <li>ELWD Condenser: N.A. 0.3 (W.D. 75 mm)</li> <li>NAMC Condenser: N.A. 0.4 (W.D. 44 mm)</li> </ul>	
<b>Sliders</b>	<ul style="list-style-type: none"> <li>T1-SNCP Non-centerable Phase Slider (PhL, Ph1, 1 empty position), T1-SCP Centerable Phase Slider (PhL, Ph1, 1 empty position), T1-SPH2 Phase Ring Ph2 (optional)</li> <li>NAMC Slider (NAMC1, NAMC2, NAMC3)</li> </ul>	
<b>Epi-fluorescence attachment</b>	T1-FM Epi-fluorescence Attachment, with field diaphragm, Fluorescence filter block holder (2 filter blocks mountable, 1 empty position), Heat absorbing filter, Lamphouse for 50 W mercury lamp, Light shielding plate, UV-cut filter (detachable)	
<b>Power consumption (max.)</b>	Normal value: 3 W (TS100/TS100-F LED model), 41 W (TS100/TS100-F halogen model)	
<b>Weight (approx.)</b>	6.5 kg (TS100/TS100-F standard set)	

\* The condenser can be removed to provide 190 mm of working distance above the stage.

Specifications and equipment are subject to change without any notice or obligation on the part of the manufacturer. January 2013 ©1999-13 NIKON CORPORATION



Monitor images are simulated.  
Company names and product names appearing in this brochure are their registered trademarks or trademarks.  
N.B. Export of the products\* in this brochure is controlled under the Japanese Foreign Exchange and Foreign Trade Law.  
Appropriate export procedure shall be required in case of export from Japan.  
\*Products: Hardware and its technical information (including software)

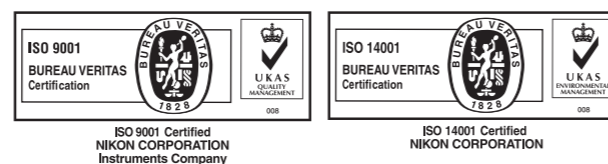

#### NIKON CORPORATION

Shin-Yurakucho Bldg., 12-1, Yurakucho 1-chome, Chiyoda-ku, Tokyo 100-8331, Japan  
phone: +81-3-3216-2375 fax: +81-3-3216-2385  
<http://www.nikon.com/instruments/>

#### NIKON INSTRUMENTS INC.

1300 Walt Whitman Road, Melville, N.Y. 11747-3064, U.S.A.  
phone: +1-631-547-8500; +1-800-52-NIKON (within the U.S.A. only)  
fax: +1-631-547-0306  
<http://www.nikoninstruments.com/>

#### NIKON INSTRUMENTS EUROPE B.V.

Tripolis 100, Burgerweeshuispad 101, 1076 ER Amsterdam, The Netherlands  
phone: +31-20-7099-0000 fax: +31-20-7099-298  
<http://www.nikoninstruments.eu/>

#### NIKON INSTRUMENTS (SHANGHAI) CO., LTD.

CHINA phone: +86-21-5836-0050 fax: +86-21-5836-0030  
(Beijing branch) phone: +86-10-5869-2255 fax: +86-10-5869-2277  
(Guangzhou branch) phone: +86-20-3882-0552 fax: +86-20-3882-0580

#### NIKON SINGAPORE PTE LTD

SINGAPORE phone: +65-6559-3618 fax: +65-6559-3668

#### NIKON MALAYSIA SDN. BHD.

MALAYSIA phone: +60-3-7809-3688 fax: +60-3-7809-3633

#### NIKON INSTRUMENTS KOREA CO., LTD.

KOREA phone: +82-2-2186-8410 fax: +82-2-555-4415

#### NIKON CANADA INC.

CANADA phone: +1-905-602-9676 fax: +1-905-602-9953

#### NIKON FRANCE S.A.S.

FRANCE phone: +33-1-4516-45-16 fax: +33-1-4516-45-55

#### NIKON GMBH

GERMANY phone: +49-211-941-42-20 fax: +49-211-941-43-22

#### NIKON INSTRUMENTS S.p.A.

ITALY phone: +39-055-300-96-01 fax: +39-055-30-09-93

#### NIKON AG

SWITZERLAND phone: +41-43-277-28-67 fax: +41-43-277-28-61

#### NIKON UK LTD.

UNITED KINGDOM phone: +44-208-247-1717 fax: +44-208-541-4584

#### NIKON GMBH AUSTRIA

AUSTRIA phone: +43-1-972-6111-00 fax: +43-1-972-6111-40

#### NIKON BELUX

BELGIUM phone: +32-2-705-56-65 fax: +32-2-726-66-45



# Inverted Microscope ECLIPSE TS100



# A new standard for inverted microscopes defined by bright high-resolution images and unrivaled usability



Trinocular type model TS100-F

Binocular type model TS100

The compact high-performance inverted microscopes ECLIPSE TS100 and TS100-F use Eco-illumination, a newly developed LED illumination. Eco-illumination provides enough brightness for phase contrast and NAMC observations. With a fly-eye lens, uniform brightness is provided in the entire field of view. LEDs are an environmentally friendly low-power-consumption light source. Eco-illumination provides a long lifetime of 60,000 hours and reduces the frequency of lamp replacement. A halogen illumination model is also available.

Nikon's highly acclaimed CFI60 optical system is used, providing flat, sharp and clear images, while achieving longer working distances and higher numerical apertures.

The space-saving body is robust and vibration-resistant, enabling safe specimen observations. The microscope controls are designed for ease of use. The ECLIPSE TS100-F comes with a photo port and is compatible with a variety of cameras. The ECLIPSE TS100 and TS100-F ensure high-quality observations for various areas, such as cell culture, inspections and research.

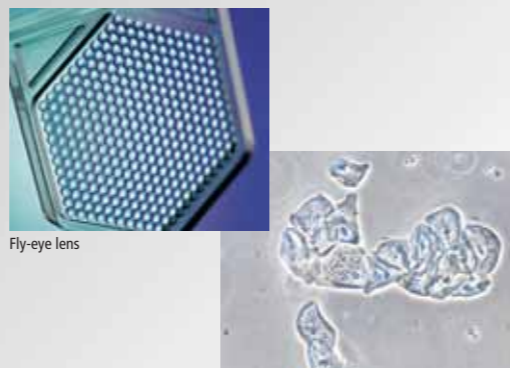

Fly-eye lens

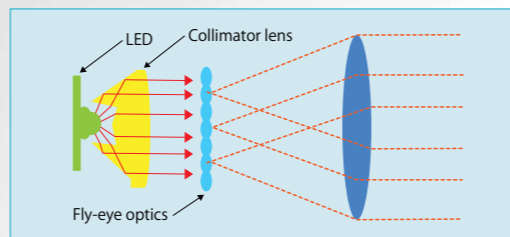

## Operation is simpler, quicker, more precise, because there is less strain on the user

### Coarse/fine focus knob

The coaxial coarse/fine focus knob, located in front of and close to the operator, makes operation at high magnifications more efficient and convenient than ever before.



### Efficient, user-friendly stage

The stage features a low-profile design that is 195 mm high, making it the ideal size for a lab bench or safety hood. Even cell cultures on the bottom of a tall flask or stacking chamber vessel can be viewed, because there is 190 mm of space above the stage when the condenser is removed.



Ample space above the stage

### Transparent stage ring

Two types of acrylic stage rings come with the main body. Because these stage rings are transparent, confirming which objective is being used is easy. The ring with the semicircular hole facilitates observation of the specimen in a chamber since it prevents the objective lens from striking the ring during magnification changes. A glass stage ring that minimizes the possibility of thermal deformation is also available as an option.



Acrylic stage ring set

Objective in use is easily identified through the transparent stage ring.

### Easy-to-rotate nosepiece

The quintuple (5-position) backward-facing nosepiece offers plenty of clearance to allow the operator to rotate it from either side. Because there is ample space around the nosepiece, handling the nosepiece is easy, even for an operator with large or gloved hands.



Plenty of clearance around the nosepiece

### Eyepiece tube

The Siedentopf-type eyepiece tube is inclined 45° and the eyepoint height is 400 mm for easy, comfortable viewing in the sitting or standing position.

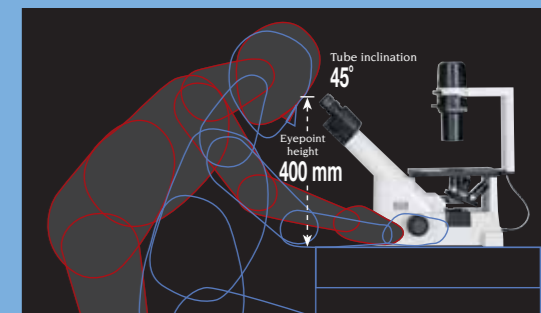

Comfortable operation

### Eyepieces

Featuring a 22-mm field of view, the widest in this class of microscope, the TS100 and TS100-F ensure clear images up to the periphery of the field of view even when using higher magnification objectives.

# Observation methods that provide the most information from your specimens

## Phase contrast method

Nikon has developed the breakthrough "Apodized" method, which has led to remarkable improvements in the quality of phase contrast images.

Nikon has successfully reduced image halos by using a process called "Apodization" to improve the phase ring of the objective. This improves vision during phase contrast microscopy by removing unwanted halos to make it possible to more clearly observe cell division activities within a specimen and view finer details within a thick specimen.



ELWD Condenser and phase sliders



TS100 configured with a phase contrast set

## The Principle of Apodized Phase Contrast Microscopy

In the conventional phase contrast method, direct light\* that has been weakened by passing through a phase ring is made to interfere with diffracted light\*\*, causing a phase shift and increasing image contrast.

The Apodized method utilizes the property of diffracted light in which a decrease in specimen size results in a greater angle of diffraction. Two absorbing bands with different transmittance have been added either side of the conventional phase ring DL to reduce halos and increase contrast in the minute structure of the specimen.

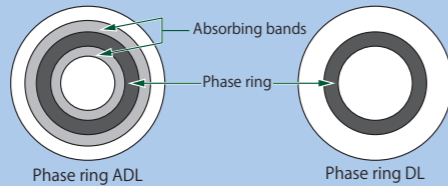

\*Light that travels retaining the original incident angle  
\*\*Light that has been diffracted by the specimen



### ADL, ADM objectives

- ① CFI Achromat ADL10X (N.A. 0.25, W.D. 6.2 mm) Ph1
- ② CFI Achromat LWD ADL20XF (N.A. 0.4, W.D. 3.1 mm) Ph1
- ③ CFI Achromat LWD ADL40XF (N.A. 0.55, W.D. 2.1 mm) Ph1
- ④ CFI Achromat LWD ADL40XC (N.A. 0.55, W.D. 2.7–1.7 mm) Ph2
- ⑤ CFI S Plan Fluor ELWD ADM20XC (N.A. 0.45, W.D. 8.2–6.9 mm) Ph1
- ⑥ CFI S Plan Fluor ELWD ADM40XC (N.A. 0.60, W.D. 3.6–2.8 mm) Ph2

## Apodized phase contrast

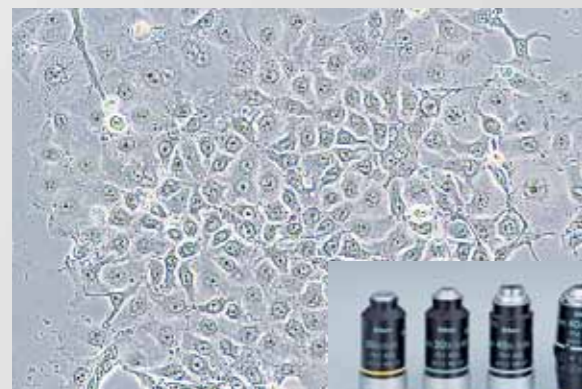

Monkey kidney: CFI LWD ADL20XF



ADL objectives for Apodized phase contrast

## Phase contrast

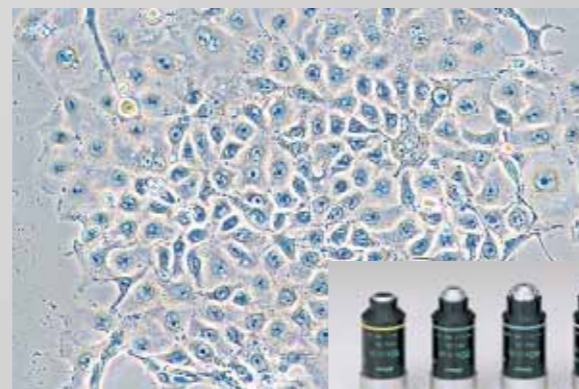

Monkey kidney: CFI LWD DL20XF



DL objectives for phase contrast

## Epi-fluorescence method

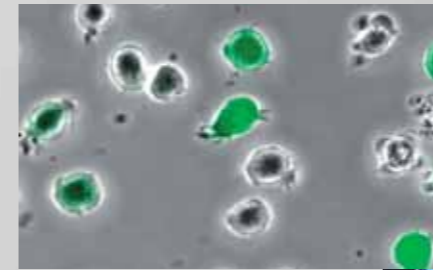

T lymphocyte cell (GFP)

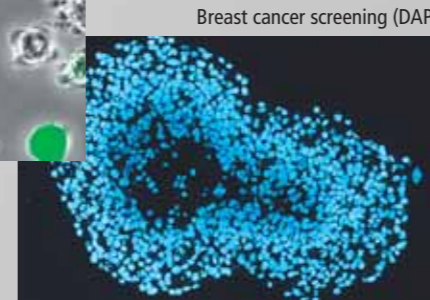

Breast cancer screening (DAPI)



TS100 configured with epi-fl attachment

This method is ideal for identifying fluorescent tagged substances within a cell, green fluorescent protein (GFP), and a myriad of other clinical and research applications.

Epi-fluorescence observation utilizing UV-range light is also possible.



Epi-fl attachment



- ① CFI Plan Fluor DL4X (N.A. 0.13, W.D. 16.4 mm) PhL
- ② CFI Plan Fluor DL10X (N.A. 0.3, W.D. 15.2 mm) Ph1
- ③ CFI Plan Fluor 10X (N.A. 0.3, W.D. 16.0 mm)
- ④ CFI S Plan Fluor ELWD20XC (N.A. 0.45, W.D. 8.2–6.9 mm)
- ⑤ CFI S Plan Fluor ELWD40XC (N.A. 0.60, W.D. 3.6–2.8 mm)
- ⑥ CFI S Plan Fluor ELWD ADM20XC (N.A. 0.45, W.D. 8.2–6.9 mm)
- ⑦ CFI S Plan Fluor ELWD ADM40XC (N.A. 0.60, W.D. 3.6–2.8 mm)

## Nikon Advanced Modulation Contrast method

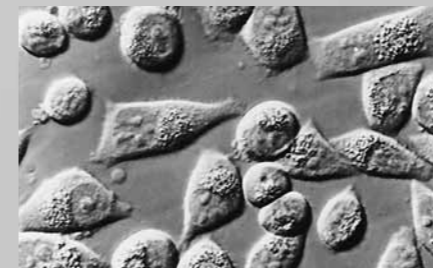

HeLa cells in tissue culture vessel

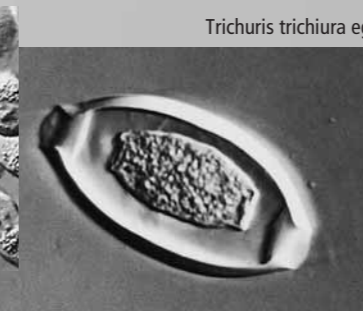

Trichuris trichiura egg

This method is now possible even with a microscope of this class. NAMC creates vivid, 3-dimensional-like images of living, transparent specimens, allowing observation in plastic petri dishes—something that DIC does not do well.



NAMC Condenser



- ① CFI Achromat NAMC 10X (N.A. 0.25, W.D. 6.2 mm)
- ② CFI Achromat LWD NAMC 20XF (N.A. 0.4, W.D. 3.1 mm)
- ③ CFI Achromat LWD NAMC 40XC (N.A. 0.55, W.D. 2.7–1.7 mm)



TS100 configured with NAMC set

# Accessories to expand your capabilities

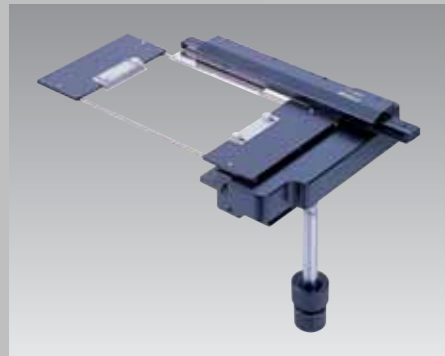

## Mechanical stage

By attaching appropriate holders, various specimen slides and micro testplates can be mounted on this stage.

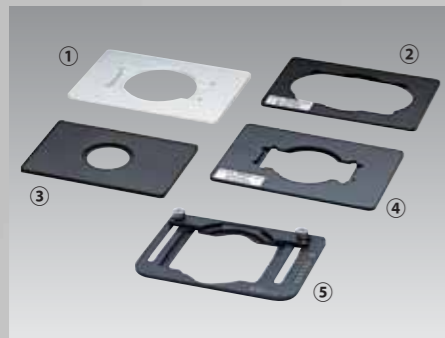

## Specimen plate holders

These specimen holders are available for use with the mechanical stage:

- ① Hemacytometer Holder
- ② Terasaki Holder (accepts ø65-mm petri dish)
- ③ ø35-mm Petri Dish Holder
- ④ Slide Glass Holder (accepts ø54-mm petri dish)
- ⑤ Universal Holder



## Auxiliary stages

For large specimens, you can widen the space on your plain stage by attaching a pair of auxiliary stages.



## Micromanipulators

The ECLIPSE TS100 and TS100-F can be configured with Nikon/Narishige micromanipulators and microinjectors for a variety of applications, including injections, aspiration, and incisions of cell tissues during cytoengineering, developmental and genetic engineering, electrophysiology, pharmacology, reproductive medicine, and neurochemistry.

## Digital Sight series camera system

The TS100-F comes with a photo port that accepts digital camera systems such as the DS-Fi2-L3, a stand-alone type digital camera with which you can capture and save images without the need for a PC. Imaging can be easily controlled using the touch panel on the control unit.



TS100-F configured with Digital Camera DS-Fi2-L3



## CCTV adapters

These CCTV adapters are available as options:

- ① C-mount TV Adapter 0.6X—recommended for 2/3" CCD camera\*
- ② C-mount TV Adapter 0.45X—recommended for 1/2" CCD camera\*
- ③ C-mount TV Adapter 0.35X—recommended for 1/3" CCD camera\*
- ④ C-mount TV Adapter VM4X\*\*
- ⑤ C-mount TV Adapter VM2.5X\*\*
- ⑥ C-mount TV Adapter A
- ⑦ V-T Photo Adapter

\*V-T Photo Adapter is necessary  
\*\*C-mount TV Adapter A is necessary

# System diagram/Dimensions

## System diagram

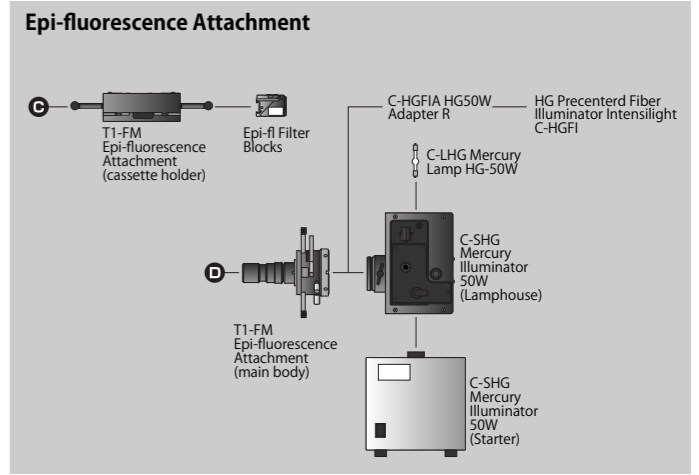
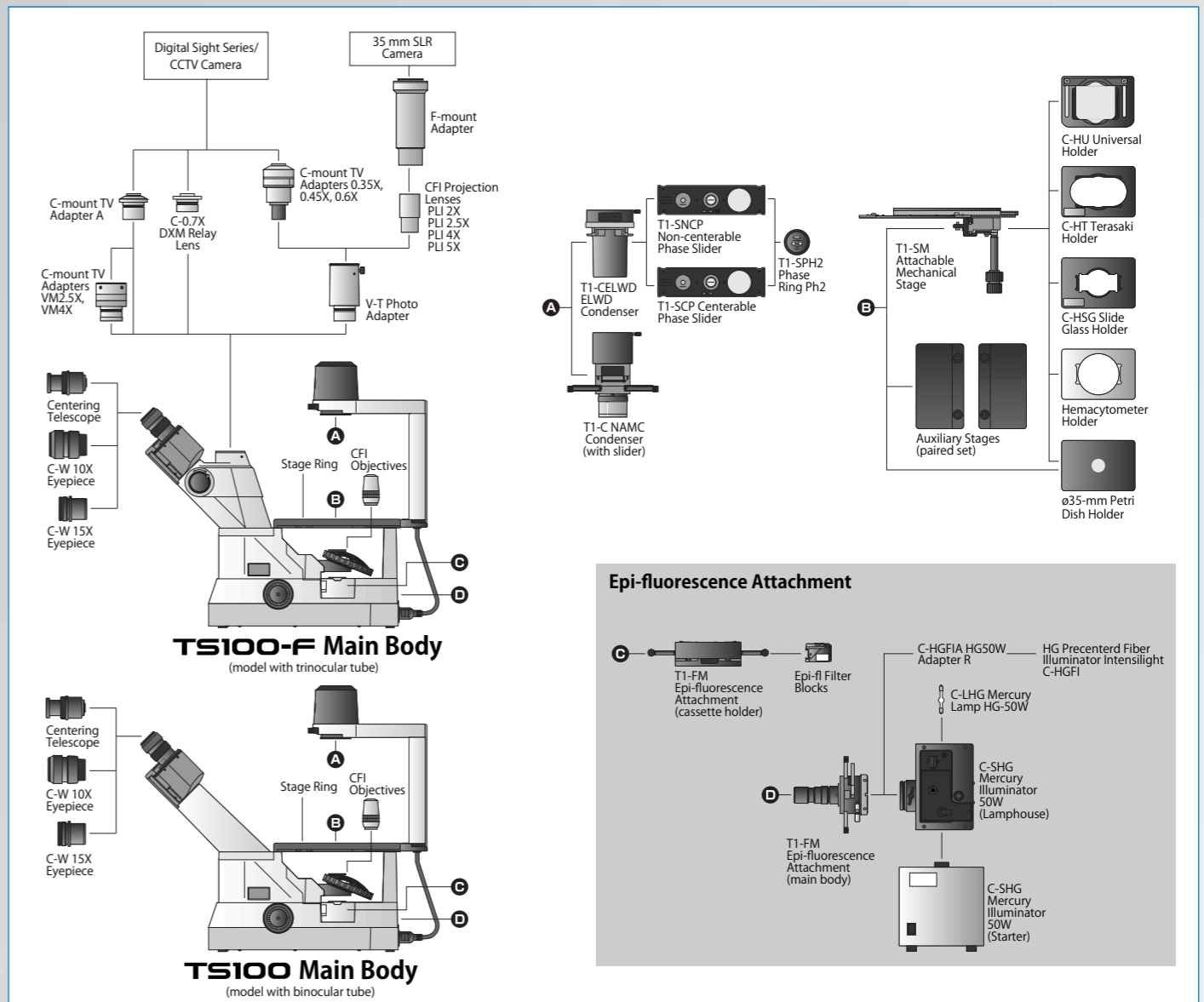

Both LED illumination and halogen illumination models are available

## Dimensions

